

Exploded View

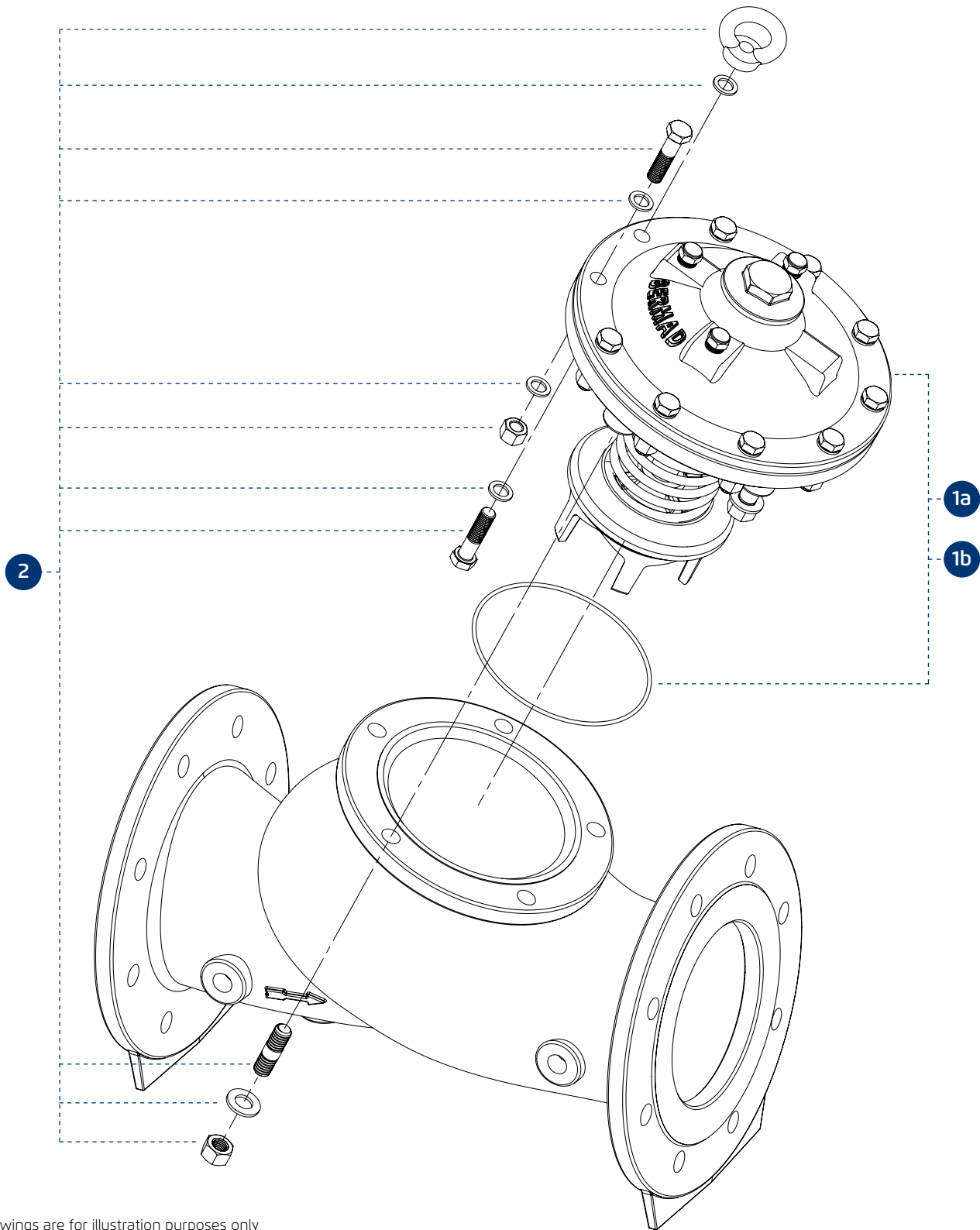

* Drawings are for illustration purposes only

- Use this document for recommended spare parts of the 700 series valves which comply to Australian drinking water standard and are with blue Epoxy coated ductile iron and EPDM elastomers.
- Please contact BERMAD for any further inquiries.

Actuators & External Bolts

	Size	1a Actuator Assembly with V-port ⁽¹⁾	1b Actuator Assembly with Flat Disc ⁽¹⁾	2 External Bolts Kit
EN	1.5"-DN40	25150PA395-K	25150PA595-K	25200S000E
	2"-DN50	25150PA395-K	25150PA595-K	25200S000E
	2.5"-DN65	25250PA395-K	25250PA595-K	25250S000E
	3"-DN80	25300PA395-K	25300PA595-K	25300S000E
	4"-DN100	25400PA395-K	25400PA595-K	25400S000E
	6"-DN150	25600PA395-K	25600PA595-K	25600S000E
	8"-DN200	25800PA395-K	25800PA595-K	25800S000E
	10"-DN250	25010PA395-K	25010PA595-K	25010S000E
	12"-DN300	25120PA395-K	25120PA595-K	25120S000E
	16"-DN400	25160PA395-K	25160PA595-K	25160S000E
ES	2.5"-DN65	25150PA395-K	25150PA595-K	25200S000E
	3"-DN80	25250PA395-K	25250PA595-K	25250S000E
	4"-DN100	25300PA395-K	25300PA595-K	25300S000E
	6"-DN150	25600P6395-K	25600P6595-K	25600SE50E
	8"-DN200	25600PA395-K	25600PA595-K	25600S000E
	10"-DN250	25800PA395-K	25800PA595-K	25800S000E
	12"-DN300	25010PA395-K	25010PA595-K	25010S000E
	14"-DN350	25120PA395-K	25120PA595-K	25120S000E
	16"-DN400	25120PA395-K	25120PA595-K	25120S000E
	18"-DN450	25160PA395-K	25160PA595-K	25160S000E
	20"-DN500	25160PA395-K	25160PA595-K	25160S000E
	24"-DN600	25160PA395-K	25160PA595-K	25160S000E
700-00	1.5"-DN40	25200PA395-K	25200PA595-K	25200S000E
	2"-DN50	25200PA395-K	25200PA595-K	25200S000E
	2.5"-DN65 grooved	25150PA395-K	25150PA595-K	25200S000E
	2.5"-DN65	25200PA395-K	25200PA595-K	25200S000E
	3"-DN80	25300PA395-K	25300PA595-K	25300S000E
	4"-DN100	25400PA395-K	25400PA595-K	25400S000E
	6"-DN150	25600PA395-K	25600PA595-K	25600S000E
	8"-DN200	25800PA395-K	25800PA595-K	25800S000E
	10"-DN250	25010PA395-K	25010PA595-K	25010S000E
	12"-DN300	25120PA395-K	25120PA595-K	25120S000E
	14"-DN350	25120PA395-K	25120PA595-K	25120S000E
	16"-DN400	25160PA395-K	25160PA595-K	25160S000E
	18"-DN450	25160PA395-K	25160PA595-K	25160S000E
	20"-DN500	25160PA395-K	25160PA595-K	25160S000E

⁽¹⁾ Drinking water compatible single chamber actuator assemblies with blue Epoxy coated ductile iron and EPDM elastomers - up to 25 bar; 400 psi.

Actuator Exploded View

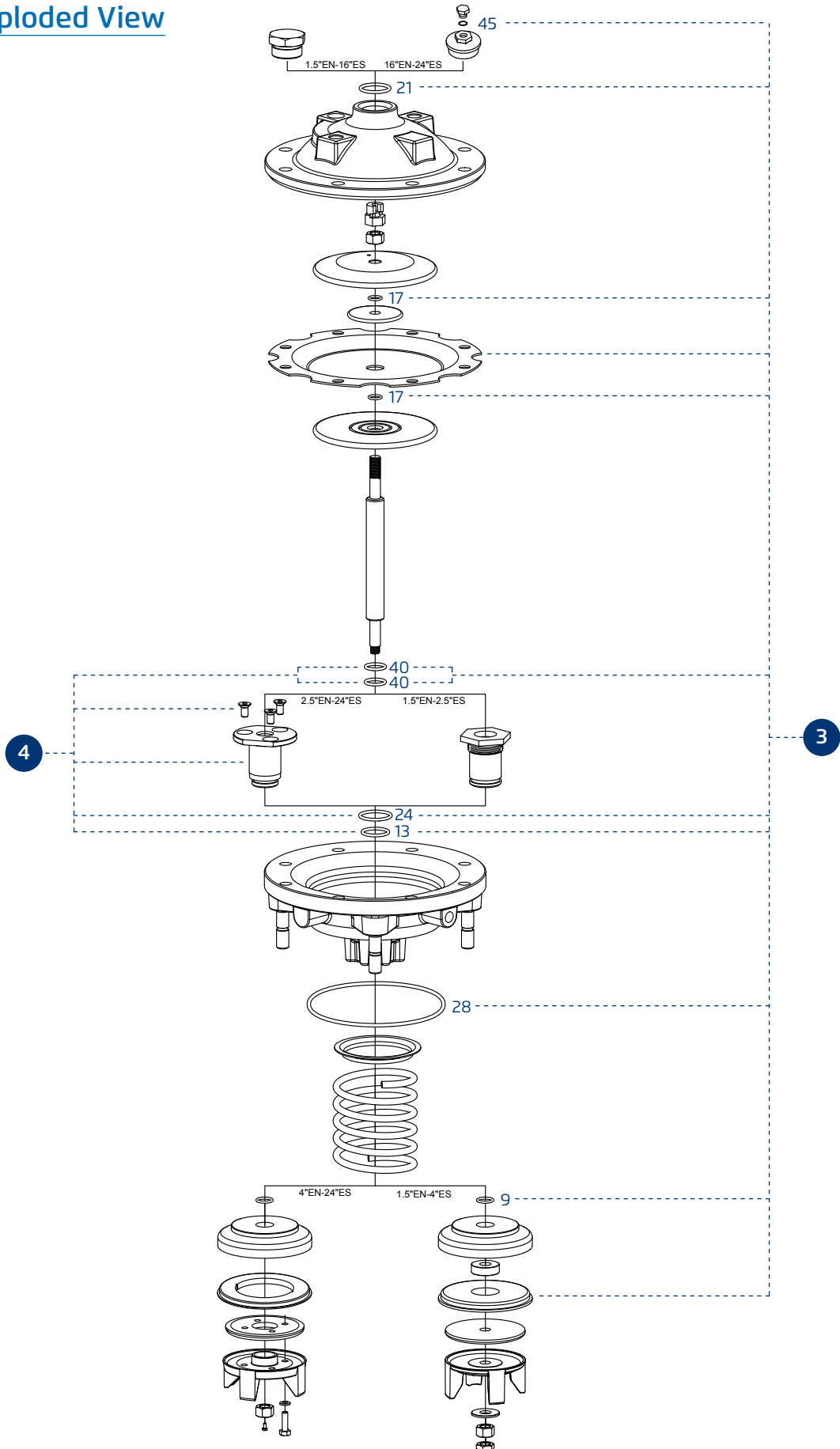

* Drawings are for illustration purposes only

Elastomers and Bearing

	Size	3 Elastomers Kit ⁽²⁾	4 Bearing Kit/Assembly ⁽²⁾
EN	1.5"-DN40	2520-0ENDH	2520056392
	2"-DN50	2520-0ENDH	2520056392
	2.5"-DN65	2525-000DH	2525056523-KIT
	3"-DN80	2530-000DH	2530056523-KIT
	4"-DN100	2540-000DH	2530056523-KIT
	6"-DN150	2560-000DH	2560056523-KIT
	8"-DN200	2580-000DH	2580056523-KIT
	10"-DN250	2501-000DH	2501056523-KIT
	12"-DN300	2512-000DH	2512056523-KIT
	16"-DN400	2516-000DH	2516056523-KIT
ES	2.5"-DN65	2520-0ENDH	2520056392
	3"-DN80	2525-000DH	2525056523-KIT
	4"-DN100	2530-000DH	2530056523-KIT
	6"-DN150	2560-0ESDH	2560S050523-KIT
	8"-DN200	2560-000DH	2560056523-KIT
	10"-DN250	2580-000DH	2580056523-KIT
	12"-DN300	2501-000DH	2501056523-KIT
	14"-DN350	2512-000DH	2512056523-KIT
	16"-DN400	2512-000DH	2512056523-KIT
	18"-DN450	2516-000DH	2516056523-KIT
	20"-DN500	2516-000DH	2516056523-KIT
	24"-DN600	2516-000DH	2516056523-KIT
700-00	1.5"-DN40	2520-000DH	2520056392
	2"-DN50	2520-000DH	2520056392
	2.5"-DN65 grooved	2520-0ENDH	2520056392
	2.5"-DN65	2520-000DH	2520056392
	3"-DN80	2530-000DH	2530056523-KIT
	4"-DN100	2540-000DH	2530056523-KIT
	6"-DN150	2560-000DH	2560056523-KIT
	8"-DN200	2580-000DH	2580056523-KIT
	10"-DN250	2501-000DH	2501056523-KIT
	12"-DN300	2512-000DH	2512056523-KIT
	14"-DN350	2512-000DH	2512056523-KIT
	16"-DN400	2516-000DH	2516056523-KIT
	18"-DN450	2516-000DH	2516056523-KIT
	20"-DN500	2516-000DH	2516056523-KIT

⁽²⁾ Drinking water compatible with EPDM elastomers - up to 25 bar; 400 psi

O-rings Size (Parker No.)

	Size	45	21	17	40	24	13	28	9	43 ⁽³⁾
EN	1.5"-DN40	N/A	2-119	2-012	5-617	2-020	2-018	2-232	2-012	2-011
	2"-DN50	N/A	2-119	2-012	5-617	2-020	2-018	2-232	2-012	2-011
	2.5"-DN65	N/A	2-119	2-012	5-617	2-120	2-118	2-237	5-617	2-011
	3"-DN80	N/A	2-119	2-012	5-617	2-121	2-118	2-237	2-012	2-011
	4"-DN100	N/A	2-119	2-012	5-617	2-121	2-118	2-246	5-617	2-011
	6"-DN150	N/A	2-227	5-617	2-212	2-126	2-124	2-364	2-212	2-011
	8"-DN200	N/A	2-227	2-116	2-216	2-130	2-127	2-372	2-216	2-011
	10"-DN250	N/A	2-227	2-118	2-218	2-132	2-130	2-379	2-218	2-011
	12"-DN300	N/A	2-227	2-120	2-326	2-139	2-227	2-456	2-223	2-011
	16"-DN400	2-119	2-236	2-223	2-333	2-238	2-340	2-466	2-230	2-011
ES	2.5"-DN65	N/A	2-119	2-012	5-617	2-020	2-018	2-232	2-012	2-011
	3"-DN80	N/A	2-119	2-012	5-617	2-120	2-118	2-237	5-617	2-011
	4"-DN100	N/A	2-119	2-012	5-617	2-121	2-118	2-237	2-012	2-011
	6"-DN150	N/A	2-227	5-617	2-212	2-126	2-124	2-359	2-212	2-011
	8"-DN200	N/A	2-227	5-617	2-212	2-126	2-124	2-364	2-212	2-011
	10"-DN250	N/A	2-227	2-116	2-216	2-130	2-127	2-372	2-216	2-011
	12"-DN300	N/A	2-227	2-118	2-218	2-132	2-130	2-379	2-218	2-011
	14"-DN350	N/A	2-227	2-120	2-326	2-139	2-227	2-456	2-223	2-011
	16"-DN400	N/A	2-227	2-120	2-326	2-139	2-227	2-456	2-223	2-011
	18"-DN450	2-119	2-236	2-223	2-333	2-238	2-340	2-466	2-230	2-011
	20"-DN500	2-119	2-236	2-223	2-333	2-238	2-340	2-466	2-230	2-011
24"-DN600	2-119	2-236	2-223	2-333	2-238	2-340	2-466	2-230	2-011	
700-00	1.5"-DN40	N/A	2-119	2-012	5-617	2-020	2-018	2-232	2-012	2-011
	2"-DN50	N/A	2-119	2-012	5-617	2-020	2-018	2-232	2-012	2-011
	2.5"-DN65	N/A	2-119	2-012	5-617	2-020	2-018	2-232	2-012	2-011
	3"-DN80	N/A	2-119	2-012	5-617	2-121	2-118	2-237	2-012	2-011
	4"-DN100	N/A	2-119	2-012	5-617	2-121	2-118	2-246	5-617	2-011
	6"-DN150	N/A	2-227	5-617	2-212	2-126	2-124	2-364	2-212	2-011
	8"-DN200	N/A	2-227	2-116	2-216	2-130	2-127	2-372	2-216	2-011
	10"-DN250	N/A	2-227	2-118	2-218	2-132	2-130	2-379	2-218	2-011
	12"-DN300	N/A	2-227	2-120	2-326	2-139	2-227	2-456	2-223	2-011
	14"-DN350	N/A	2-227	2-120	2-326	2-139	2-227	2-456	2-223	2-011
	16"-DN400	2-119	2-236	2-223	2-333	2-238	2-340	2-466	2-230	2-011
	18"-DN450	2-119	2-236	2-223	2-333	2-238	2-340	2-466	2-230	2-011
20"-DN500	2-119	2-236	2-223	2-333	2-238	2-340	2-466	2-230	2-011	

⁽³⁾ Relevant only for actuators with an indicator rod i.e.: I, S

Additional Attributes



	Size	Position Indicator Assy.- I	Single Limit Switch Assy.- S	Double Limit Switch Assy.- SS	Flow Stem Assy.- M
EN	1.5"-DN40	25300S6394	25200S6394	2520006362	25200S6093
	2"-DN50	25300S6394	25200S6394	2520006362	25200S6093
	2.5"-DN65	25300S6394	25200S6394	2520006362	25200S6093
	3"-DN80	25300S6394	25200S6394	2520006362	25200S6093
	4"-DN100	25300S6394	25200S6394	2520006362	25200S6093
	6"-DN150	25600S6360	25600S6394	2560006362	25600S6093
	8"-DN200	25600S6360	25600S6394	2580006362	25600S6093
	10"-DN250	25010S6360	25010S6394	2580006362	25010S6093
	12"-DN300	25010S6360	25010S6394	2580006362	25010S6093
16"-DN400	25160S6360	25160S6394	2516006362	25160S6093	
ES	2.5"-DN65	25300S6394	25200S6394	2520006362	25200S6093
	3"-DN80	25300S6394	25200S6394	2520006362	25200S6093
	4"-DN100	25300S6394	25200S6394	2520006362	25200S6093
	6"-DN150	25600S6360	25600S6394	2560006362	25600S6093
	8"-DN200	25600S6360	25600S6394	2560006362	25600S6093
	10"-DN250	25600S6360	25600S6394	2580006362	25600S6093
	12"-DN300	25010S6360	25010S6394	2580006362	25010S6093
	14"-DN350	25010S6360	25010S6394	2580006362	25010S6093
	16"-DN400	25010S6360	25010S6394	2580006362	25010S6093
	18"-DN450	25160S6360	25160S6394	2516006362	25160S6093
	20"-DN500	25160S6360	25160S6394	2516006362	25160S6093
24"-DN600	25160S6360	25160S6394	2516006362	25160S6093	
700-00	1.5"-DN40	25300S6394	25200S6394	2520006362	25200S6093
	2"-DN50	25300S6394	25200S6394	2520006362	25200S6093
	2.5"-DN65	25300S6394	25200S6394	2520006362	25200S6093
	3"-DN80	25300S6394	25200S6394	2520006362	25200S6093
	4"-DN100	25300S6394	25200S6394	2520006362	25200S6093
	6"-DN150	25600S6360	25600S6394	2560006362	25600S6093
	8"-DN200	25600S6360	25600S6394	2580006362	25600S6093
	10"-DN250	25010S6360	25010S6394	2580006362	25010S6093
	12"-DN300	25010S6360	25010S6394	2580006362	25010S6093
	14"-DN350	25010S6360	25010S6394	2580006362	25010S6093
	16"-DN400	25160S6360	25160S6394	2516006362	25160S6093
	18"-DN450	25160S6360	25160S6394	2516006362	25160S6093
20"-DN500	25160S6360	25160S6394	2516006362	25160S6093	