



Hermon Laboratories Ltd.
66 HaTachana str., P.O. Box 23, Binyamina
3055001, Israel
Tel. +972 4628 8001
Fax. +972 4628 8277
E-mail: mail@hermonlabs.com

TEST REPORT

ACCORDING TO:

EN IEC 61326-1: 2021, basic immunity requirements, Class A

EN 301 489-17: V3.3.1: 2024, Class A

EN 301 489-1: V2.2.3: 2019, Class A

FOR:

Bermad CS. Ltd

Smart Irrigation Controller

Models:

Omega B

Omega G

This report is in conformity with ISO/ IEC 17025. The "A2LA Accredited" symbol endorsement applies only to the tests and calibrations that are listed in the scope of Hermon Laboratories accreditation. The test results relate only to the items tested.
This test report shall not be reproduced in any form except in full with the written approval of Hermon Laboratories Ltd.

Table of contents

1	Applicant information.....	3
2	Equipment under test attributes	3
3	Manufacturer information	3
4	Test details.....	3
5	Tests summary.....	4
6	EUT description.....	5
6.1	General information.....	5
6.2	EUT RF module	5
6.3	Auxiliary equipment.....	5
6.4	Operating frequencies.....	5
6.5	Test configuration.....	5
6.6	Performance criteria	6
6.7	Acceptance criteria.....	7
7	Emissions tests according to EN IEC 61326-1, EN 301 489-17/1 requirements.....	8
7.1	Radiated emission measurements	8
8	Immunity tests according to EN IEC 61326-1, EN 301 489-17/52/1 requirements.....	13
8.1	Immunity to electrostatic discharge (ESD)	13
8.2	Radiated immunity to radio frequency electromagnetic field	17
8.3	Immunity to power frequency magnetic fields	20
9	APPENDIX A Test equipment and ancillaries used for tests.....	23
10	APPENDIX B Test laboratory description.....	24
11	APPENDIX C Abbreviations and acronyms	25
12	APPENDIX D Test equipment correction factors	26
13	APPENDIX E Measurement uncertainties.....	29
14	APPENDIX F Specification references.....	31
15	APPENDIX G Manufacturer's declaration	32

1 Applicant information

Client name: Bermad CS. Ltd
Address: Kibbutz Evron, 2280800, Israel
Telephone: +972-73-2657275
Fax: +972 73-2657692
E-mail: Ronit_a@bermad.com
Contact name: Ms. Ronit Mendel Assor

2 Equipment under test attributes

Product name: Smart Irrigation Controller

Trade Mark:



Model: Omega B ^{Note}
Serial number: OB00000000000144
Hardware version: 7.1.3.5
Software release: 1.0.60
Receipt date: 08-Oct-25

Note: According to manufacturer's declaration provided in Apendix G of the test report, Omega B nd Omega G models are electronically/electrically/mechanically similar except of the type of solenoid. Omega B was tested as representative of the worst case configuration.

3 Manufacturer information

Manufacturer name: Bermad CS. Ltd
Address: Kibbutz Evron, 2280800, Israel
Telephone: +972-73-2657275
Fax: +972 73-2657692
E-mail: Ronit_a@bermad.com
Contact name: Ms. Ronit Mendel Assor



4 Test details

Project ID: 154735
Location: Hermon Laboratories Ltd. 66 HaTachana str., P.O. Box 23, Binyamina 3055001, Israel
Test started: 08-Oct-25
Test completed: 30-Oct-25
Test specifications: EN IEC 61326-1: 2021, basic immunity requirements, Class A
EN 301 489-17: V3.3.1: 2024, Class A
EN 301 489-1: V2.2.3: 2019, Class A

5 Tests summary

Test	Status
EN IEC 61326-1, basic immunity requirements / EN 301 489-17/1	
Class A, Conducted emissions at mains terminals	Not required
Class A, Conducted emission measurements at DC power input port	Not required
Class A, Conducted emissions from wired network ports	Not required
Class A, Radiated emissions	Pass
Harmonic current emissions	Not required
Voltage fluctuations and flicker	Not required
Immunity to electrostatic discharge (ESD)	Pass
Radiated immunity to radio frequency electromagnetic field	Pass
Conducted immunity to electrical fast transients/ bursts (EFT/ B)	Not required
Conducted immunity to voltage surges	Not required
Conducted immunity to disturbances induced by radio frequency field	Not required
Radiated immunity to power frequency magnetic field	Pass
Conducted immunity to voltage dips and short interruptions	Not required

Testing was completed against all relevant requirements of the test standard. The results obtained indicate that the product under test complies in full with the requirements tested.
The test results relate only to the items tested. Pass/ fail decision was based on nominal values.

	Name and Title	Date	Signature
Tested by:	Mr. K. Hlebnikov, Test Engineer	October 30, 2025	
Reviewed by:	Ms. N. Averin, Certification Specialist, EMC & Radio	November 24, 2025	
Approved by:	Mr. B. Attar, EMC Team Leader	March 1, 2026	

6 EUT description

Note: The following data in this clause is provided by the customer and represents his sole responsibility.

6.1 General information

The EUT, Omega B, is an advanced cloud-based irrigation controller. It provides a user-friendly and cost-effective solution for irrigation heads as well as water distribution, data acquisition, and pre-paid system. Real-time alert notifications to a PC, tablet, and smartphone. Technician mode debugging via BLE. The EUT is a battery fed (3V) device.

6.2 EUT RF module

Description	Manufacturer	Model or P/N
Stand-alone Bluetooth 5	RAYTAC	MDBT50Q-P512K

6.3 Auxiliary equipment

Description	Manufacturer	Model or P/N
Tablet computer	Teclast	P30

6.4 Operating frequencies

Source	Frequency, MHz					
Clock	<100	---	---	---	---	---
BLE	2400-2483.5	---	---	---	---	---

6.5 Test configuration

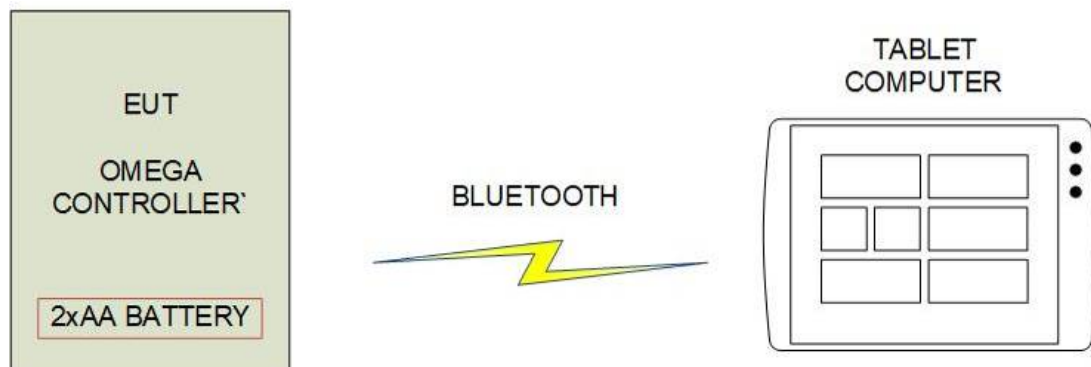

6.6 Performance criteria

6.6.1 Performance criteria of EN IEC 61326-1, Section 6.4

6.6.1.1 Performance criterion A

The equipment shall continue to operate as intended during and after the test. No DEGRADATION OF PERFORMANCE or LOSS OF FUNCTION is allowed below a PERFORMANCE LEVEL specified in the user documentation, when the equipment is used as intended. In the case of applying immunity tests with continuous electromagnetic phenomena, the PERFORMANCE LEVEL may be replaced by a permissible LOSS OF PERFORMANCE which shall recover, without user intervention. A permissible LOSS OF PERFORMANCE is allowed within the PERFORMANCE LEVEL only when this information is clearly provided to the end user via documentation, such as the product user manual. No change in the operating state is allowed nor is loss of data.

6.6.1.2 6.4.3 Performance criterion B

The equipment shall continue to operate as intended after the test. No DEGRADATION OF PERFORMANCE or LOSS OF FUNCTION is allowed below a PERFORMANCE LEVEL specified in the user documentation, when the equipment is used as intended. During the test, the equipment PERFORMANCE LEVEL may be replaced by a permissible LOSS OF PERFORMANCE if such LOSS OF PERFORMANCE is detailed in the EMC test plan. A permissible LOSS OF PERFORMANCE is allowed within the PERFORMANCE LEVEL only when this information is clearly provided to the end user via documentation, such as the product user manual. An unintended change of the operating state is allowed if self-recoverable. No loss of stored data is allowed.

The following are examples of performance criterion B:

- Data transfer is controlled or checked by parity check or by other means. In the case of malfunction, such as caused by a surge impulse, the data transfer will be repeated automatically. A reduced data transfer rate at this time is allowable degradation.
- During testing, an analogue function value may deviate in excess of the specified limits. After the test, the deviation vanishes.
- In the case of a monitor used only for man-machine monitoring, it is allowable that some degradation takes place, such as momentary display interference during the application of burst impulses.

6.6.1.3 6.4.4 Performance criterion C

LOSS OF FUNCTION is allowed, provided the function is self-recoverable or can be restored by the operation of the controls. Recovery procedure shall be included in the user documentation. No permanent damage to the equipment is allowed.

The following are examples of performance criterion C:

- In the case of an interruption in the mains longer than the specified buffer time, the power supply unit of the equipment is switched off. The switch-on may be automatic or carried out by the operator.
- After a programme interruption caused by a disturbance, the processor functions of the equipment stops at a defined position and is not left in a "crashed state". An operator's action may be necessary.
- The test results in an opening of an over-current protection equipment that can be reset by the operator.

6.6.2 Performance criteria according to EN 301-489-1

6.6.2.1 Performance criteria for continuous phenomena, Section 6.1

During the test, the equipment shall:

- continue to operate as intended;
- not unintentionally transmit;
- not unintentionally change its operating state;
- not unintentionally change critical stored data.

6.6.2.2 Performance criteria for transient phenomena, Section 6.2

For all ports and transient phenomena with the exception described below, the following applies:

- The application of the transient phenomena shall not result in a change of the mode of operation (e.g. unintended transmission) or the loss of critical stored data.
- After application of the transient phenomena, the equipment shall operate as intended.

For surges applied to symmetrically operated wired network ports intended to be connected directly to outdoor lines the following criteria applies:

- For products with only one symmetrical port intended for connection to outdoor lines, loss of function is allowed, provided the function is self-recoverable, or can be otherwise restored. Information stored in non-volatile memory, or protected by a battery backup, shall not be lost.
- For products with more than one symmetrical port intended for connection to outdoor lines, loss of function on the port under test is allowed, provided the function is self-recoverable. Information stored in non-volatile memory, or protected by a battery backup, shall not be lost.

6.6.2.3 Performance criteria for voltage dips and interruptions, Section 9.7.3

For a 0 % residual voltage dip tests the following performance criteria apply:

- The performance criteria for transient phenomena shall apply (as specified in clause 6.2).

For a 70 % residual voltage dip and voltage interruption tests, the following performance criteria apply:

- in the case where the equipment is fitted with or connected to a battery back-up, the performance criteria for transient phenomena shall apply as specified in clause 6.2);
- in the case where the equipment is powered solely from the AC mains supply (without the use of a parallel battery back-up) volatile user data may have been lost and if applicable the communication link need not to be maintained and lost functions should be recoverable by user or operator;
- no unintentional responses shall occur at the end of the test, when the voltage is restored to nominal;
- in the event of loss of function(s) or in the event of loss of user stored data, this fact shall be recorded.

6.6.3 Performance criteria according to EN 301-489-17

6.6.3.1 General performance criteria, Section 6.1

The performance criteria are:

- performance criteria A for immunity tests with phenomena of a continuous nature;
- performance criteria B for immunity tests with phenomena of a transient nature;
- performance criteria C for immunity tests with power interruptions exceeding a certain time.

6.6.3.2 Performance table, Section 6.2

Criteria	During test	After test
A	Shall operate as intended (see note) Shall be no loss of function Shall be no unintentional transmissions	Shall operate as intended Shall be no degradation of performance Shall be no loss of function Shall be no loss of critical stored data
B	May be loss of function	Functions shall be self-recoverable Shall operate as intended after recovering Shall be no loss of critical stored data
C	May be loss of function	Functions shall be recoverable by the operator Shall operate as intended after recovering Shall be no loss of critical stored data

NOTE 1: Operate as intended during the test allows a level of degradation in accordance with clause 6.2.2 of EN 301 489-17.

6.6.3.3 Performance criteria for continuous phenomena, Section 6.3

The performance criteria A shall apply.

Where the EUT is a transmitter in standby mode, unintentional transmission shall not occur during the test.

Where the EUT is a transceiver in receive mode, unintentional transmission shall not occur during the test.

6.6.3.4 Performance criteria for transient phenomena, Section 6.4

The performance criteria B shall apply, except for voltage dips greater than or equal to 100 ms and voltage interruptions of 5 000 ms duration, for which performance criteria C shall apply.

Where the EUT is a transmitter in standby mode, unintentional transmission shall not occur as a result of the application of the test.

Where the EUT is a transceiver in receive mode, unintentional transmission shall not occur as a result of the application of the test.

6.7 Acceptance criteria

The EUT operation shall be monitored via tablet applications.

Remote operation of solenoid from tablet shall be checked.

The EUT status must remain "Device in range" continuously.



Test specification:	Radiated emission measurements, Class A		
Test procedure:	EN IEC 61326-1, Section 7.2, CISPR 11, Section 6.2.2; EN 301 489-1, Section 8.2, EN 55032, Section 8, Table 1, Annex A.2, Table A.2/3, Table A.4/5, Annex C.3, Section C.3.4; CISPR 16-2-3		
Test mode:	Compliance	Verdict:	PASS
Date(s):	09-Oct-25		
Temperature: 25 °C	Relative Humidity: 48 %	Air Pressure: 1010 hPa	Power: 3 VDC
Remarks:			

7 Emissions tests according to EN IEC 61326-1, EN 301 489-17/1 requirements

7.1 Radiated emission measurements

7.1.1 General

This test was performed to measure radiated emissions from the EUT enclosure. The specification test limits are given in Table 7.1.1.

Table 7.1.1 Radiated emission limits

EN IEC 61326-1, CISPR 11								
Frequency, MHz	Class B limit, dB(µV/m)			Class A limit, dB(µV/m)				
	10 m distance	3 m distance		10 m distance	3 m distance			
30 - 230	30.0	40.0*		40.0	50.0*			
230 - 1000	37.0	47.0*		47.0	57.0*			
EN 301 489-1								
Frequency, MHz	Class B limit, dB(µV/m)				Class A limit, dB(µV/m)			
	Peak @3 m	Quasi-peak		Average @3 m	Peak @3 m	Quasi-peak		Average @3 m
		@10 m	@3 m			@10 m	@3 m	
30 - 230	—	30.0	40.0*	—	—	40.0	50.0*	—
230 - 1000	—	37.0	47.0*	—	—	47.0	57.0*	—
1000 - 3000	70	—	—	50	76	—	—	56
3000 - 6000	74	—	—	54	80	—	—	60

* The limit for 3 meters test distance was calculated by adding 10 dB to the 10 meters limit.

7.1.2 Test procedure

7.1.2.1 30 – 1000 MHz range. The EUT was set up as shown in Figure 7.1.1 and the associated photographs, energized and the EUT performance was checked.

7.1.2.2 The measurements were performed in the semi anechoic chamber at 3 m test distance. The specified frequency range was investigated with the antenna connected to the EMI receiver. To find the highest emission the turntable was rotated 360° and the measuring antenna height was swept from 1 to 4 m in both, vertical and horizontal polarizations. The EUT cables position was varied to maximize emission.

7.1.2.3 1000 – 6000 MHz range. The EUT was set up as shown in Figure 7.1.2 and the associated photographs, energized and the EUT performance was checked.

7.1.2.4 The measurements were performed in the semi anechoic chamber at 3 m test distance. The specified frequency range was investigated with the antenna connected to the EMI receiver. To find maximum radiation the turntable was rotated 360° and the measuring antenna was installed at fixed height pointed to the physical center of the EUT in both, vertical and horizontal polarizations.

7.1.2.5 The worst test results with respect to the limits were recorded in Table 7.1.2 and shown in the associated plots.



Test specification:	Radiated emission measurements, Class A		
Test procedure:	EN IEC 61326-1, Section 7.2, CISPR 11, Section 6.2.2; EN 301 489-1, Section 8.2, EN 55032, Section 8, Table 1, Annex A.2, Table A.2/3, Table A.4/5, Annex C.3, Section C.3.4; CISPR 16-2-3		
Test mode:	Compliance	Verdict:	PASS
Date(s):	09-Oct-25		
Temperature: 25 °C	Relative Humidity: 48 %	Air Pressure: 1010 hPa	Power: 3 VDC
Remarks:			

Figure 7.1.1 Setup for radiated emission measurements in semi anechoic chamber below 1 GHz, table-top EUT

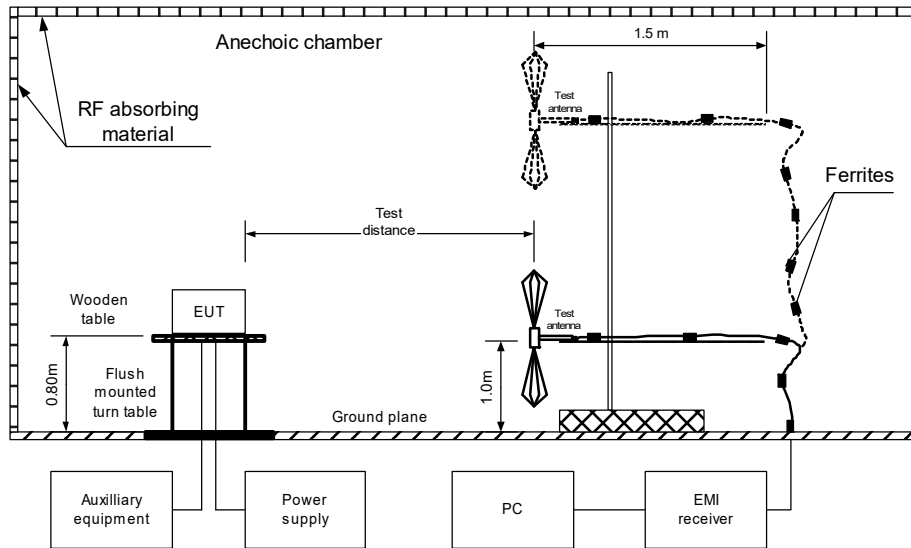
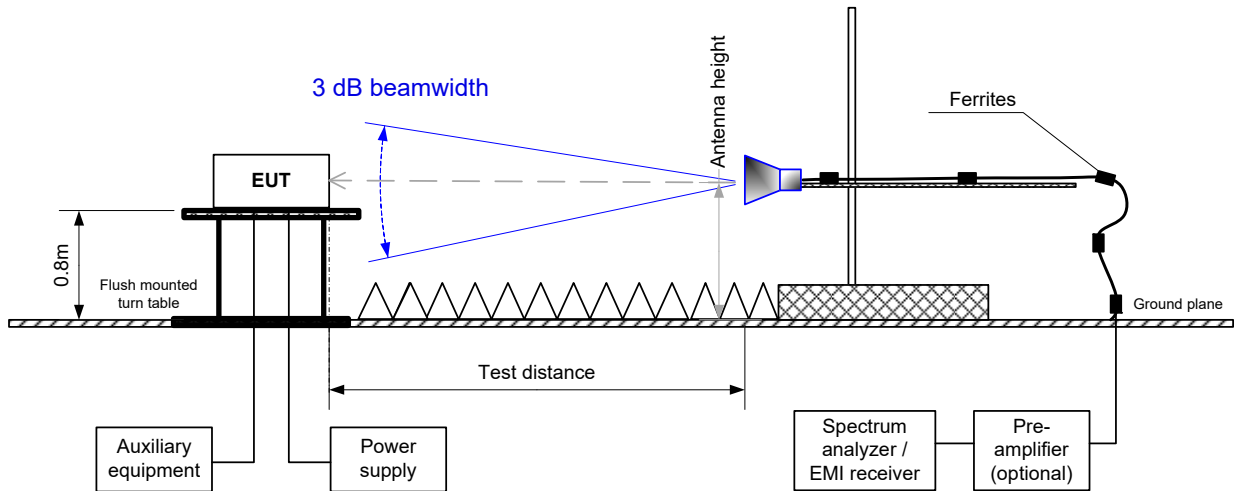

Figure 7.1.2 Setup for radiated emission measurements in semi anechoic chamber above 1 GHz, table-top EUT





Test specification:	Radiated emission measurements, Class A		
Test procedure:	EN IEC 61326-1, Section 7.2, CISPR 11, Section 6.2.2; EN 301 489-1, Section 8.2, EN 55032, Section 8, Table 1, Annex A.2, Table A.2/3, Table A.4/5, Annex C.3, Section C.3.4; CISPR 16-2-3		
Test mode:	Compliance	Verdict:	PASS
Date(s):	09-Oct-25		
Temperature: 25 °C	Relative Humidity: 48 %	Air Pressure: 1010 hPa	Power: 3 VDC
Remarks:			

Photograph 7.1.1 Setup for radiated emission measurements, general view

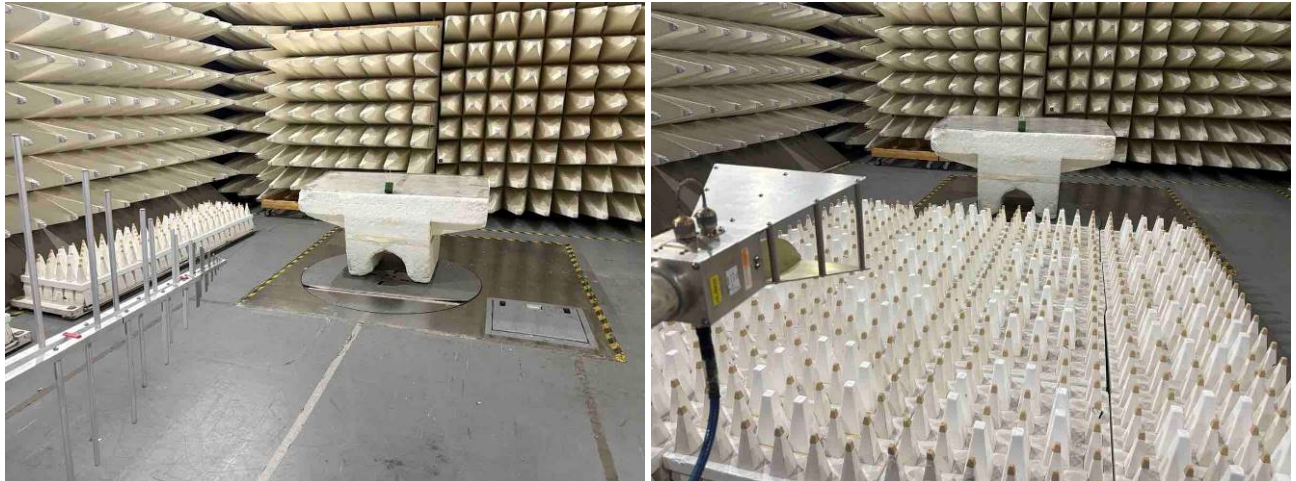

Photograph 7.1.2 Setup for radiated emission measurements, EUT view





Test specification:	Radiated emission measurements, Class A		
Test procedure:	EN IEC 61326-1, Section 7.2, CISPR 11, Section 6.2.2; EN 301 489-1, Section 8.2, EN 55032, Section 8, Table 1, Annex A.2, Table A.2/3, Table A.4/5, Annex C.3, Section C.3.4; CISPR 16-2-3		
Test mode:	Compliance	Verdict:	PASS
Date(s):	09-Oct-25		
Temperature: 25 °C	Relative Humidity: 48 %	Air Pressure: 1010 hPa	Power: 3 VDC
Remarks:			

Table 7.1.2 Radiated emission test results

EUT SET UP: TABLE-TOP
TEST SITE: SEMI ANECHOIC CHAMBER
TEST DISTANCE: 3 m
FREQUENCY RANGE: 30 MHz – 1000 MHz
DETECTORS USED: PEAK / QUASI-PEAK
RESOLUTION BANDWIDTH: 120 kHz

Frequency, MHz	Peak emission, dB(μV/m)	Quasi-peak			Antenna polarization	Antenna height, m	Turn-table position**, degrees	Verdict
		Measured emission, dB(μV/m)	Limit, dB(μV/m)	Margin, dB*				
46.181	21.18	15.26	50.00	-34.74	Horizontal	2.00	29	Pass
52.896	21.47	15.12	50.00	-34.88	Horizontal	2.57	-41	
65.860	34.55	27.88	50.00	-22.12	Horizontal	2.54	77	
445.566	46.43	43.43	57.00	-13.57	Horizontal	1.41	40	
727.627	32.43	25.03	57.00	-31.97	Horizontal	1.40	-112	

FREQUENCY RANGE: 1000 MHz - 6000 MHz
DETECTORS USED: PEAK / AVERAGE
RESOLUTION BANDWIDTH: 1 MHz

Frequency, MHz	Peak			Average			Antenna polarization	Antenna height, m	Turn-table position**, degrees	Verdict
	Measured emission, dB(μV/m)	Limit, dB(μV/m)	Margin, dB*	Measured emission, dB(μV/m)	Limit, dB(μV/m)	Margin, dB*				
All emissions were more than 20 dB below limit.										Pass

*- Margin = Measured emission - specification limit.

** - EUT front panel refers to 0 degrees position of turntable.

Reference numbers of test equipment used

HL 4015	HL 3903	HL 4933	HL 4360	HL 5288	HL 5902		
---------	---------	---------	---------	---------	---------	--	--

Full description is given in Appendix A.



Test specification:	Radiated emission measurements, Class A		
Test procedure:	EN IEC 61326-1, Section 7.2, CISPR 11, Section 6.2.2; EN 301 489-1, Section 8.2, EN 55032, Section 8, Table 1, Annex A.2, Table A.2/3, Table A.4/5, Annex C.3, Section C.3.4; CISPR 16-2-3		
Test mode:	Compliance	Verdict:	PASS
Date(s):	09-Oct-25		
Temperature: 25 °C	Relative Humidity: 48 %	Air Pressure: 1010 hPa	Power: 3 VDC
Remarks:			

Plot 7.1.1 Radiated emission measurements in 30 - 1000 MHz range, vertical & horizontal antenna polarization

TEST SITE:
TEST DISTANCE:

Semi anechoic chamber
3 m

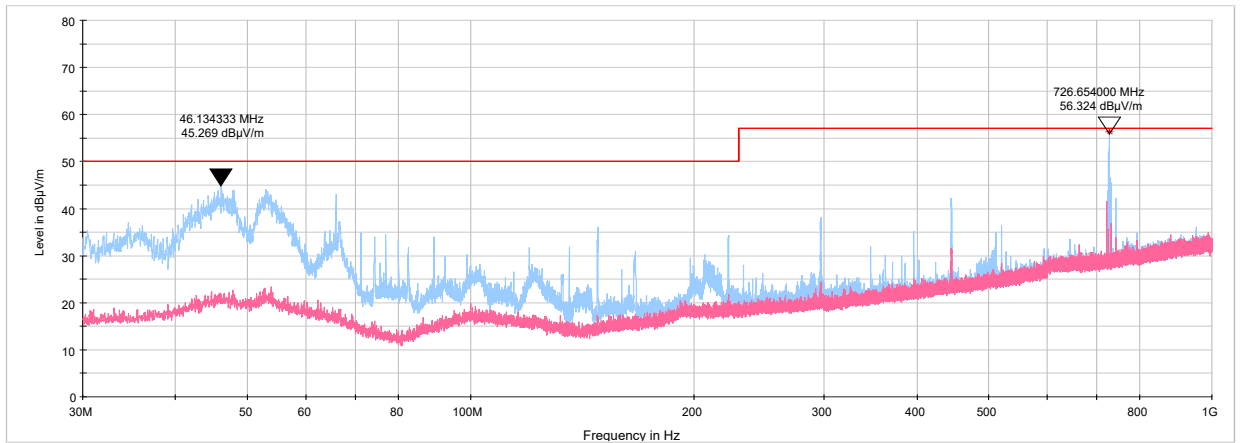

Plot 7.1.2 Radiated emission measurements in 1000 - 6000 MHz range, vertical & horizontal antenna polarization

TEST SITE:
TEST DISTANCE:

Semi anechoic chamber
3 m

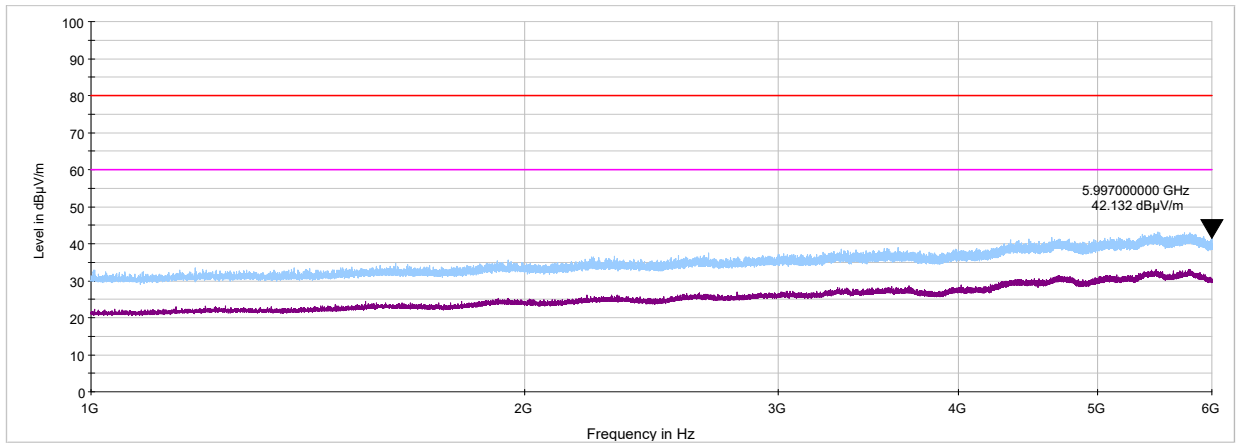



Test specification:	Immunity to electrostatic discharge (ESD)		
Test procedure:	EN 61000-4-2; EN IEC 61326-1, Table 1; EN 301 489-1, Section 9.3		
Test mode:	Compliance	Verdict:	PASS
Date(s):	08-Oct-25		
Temperature: 26 °C	Relative Humidity: 46 %	Air Pressure: 1010 hPa	Power: 3 VDC
Remarks:			

8 Immunity tests according to EN IEC 61326-1, EN 301 489-17/52/1 requirements

8.1 Immunity to electrostatic discharge (ESD)

8.1.1 General

This test was performed to verify the EUT immunity to electrostatic discharges from operators directly and from adjacent objects. The ESDs were applied to all parts of the EUT, which are accessible during normal operation and maintenance.

The ESD levels, performance criterion and test results are referred to in Table 8.1.1.

8.1.2 Test procedure

- 8.1.2.1 The EUT was set up as shown in Figure 8.1.1 and the associated photographs, energized and the EUT performance was checked.
- 8.1.2.2 Single contact discharges of both polarities with 1 s time interval between pulses were applied to the horizontal coupling plane (HCP) at 10 centimeter distance from the EUT. Each side of the EUT was subjected to ESDs.
- 8.1.2.3 Single contact discharges of both polarities with 1 s time interval between pulses were applied to the vertical coupling plane (VCP) placed 10 centimeters from the EUT. The VCP was moved, in turn, to all sides of the EUT and it was subjected to the ESDs.
- 8.1.2.4 Single contact discharges of both polarities with 1 s time interval between pulses were applied to conductive parts of the EUT cabinet.
- 8.1.2.5 Single air discharges of both polarities with 1 s time interval between pulses were applied to non-conductive parts of the EUT.
- 8.1.2.6 The EUT operation was monitored throughout the test for any malfunction or degradation and its performance was recorded.
- 8.1.2.7 Upon this the test was completed.



Test specification:	Immunity to electrostatic discharge (ESD)		
Test procedure:	EN 61000-4-2; EN IEC 61326-1, Table 1; EN 301 489-1, Section 9.3		
Test mode:	Compliance	Verdict:	PASS
Date(s):	08-Oct-25		
Temperature: 26 °C	Relative Humidity: 46 %	Air Pressure: 1010 hPa	Power: 3 VDC
Remarks:			

Figure 8.1.1 Setup for immunity to ESD, table-top EUT

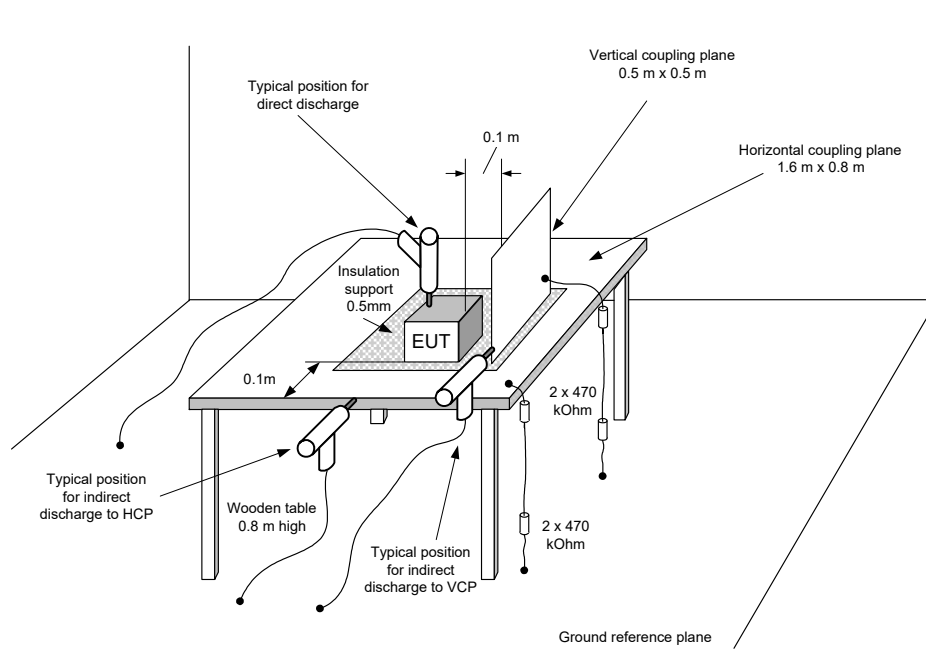

Photograph 8.1.1 Setup for immunity to ESD, general view





Test specification:	Immunity to electrostatic discharge (ESD)		
Test procedure:	EN 61000-4-2; EN IEC 61326-1, Table 1; EN 301 489-1, Section 9.3		
Test mode:	Compliance	Verdict:	PASS
Date(s):	08-Oct-25		
Temperature: 26 °C	Relative Humidity: 46 %	Air Pressure: 1010 hPa	Power: 3 VDC
Remarks:			

Photograph 8.1.2 Setup for immunity to ESD, EUT test points

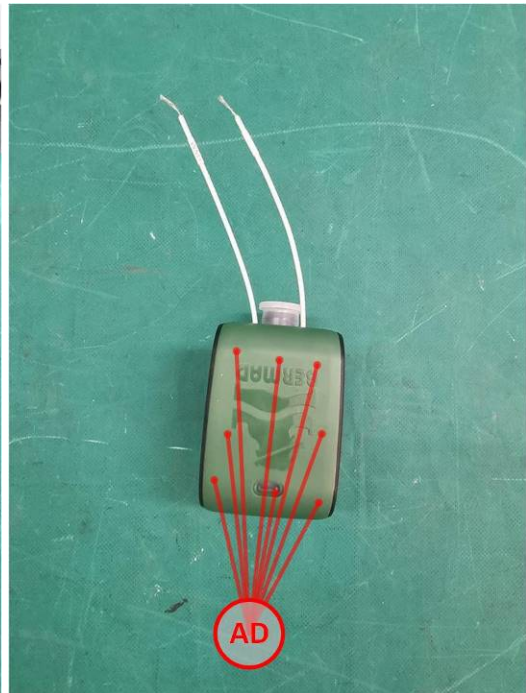
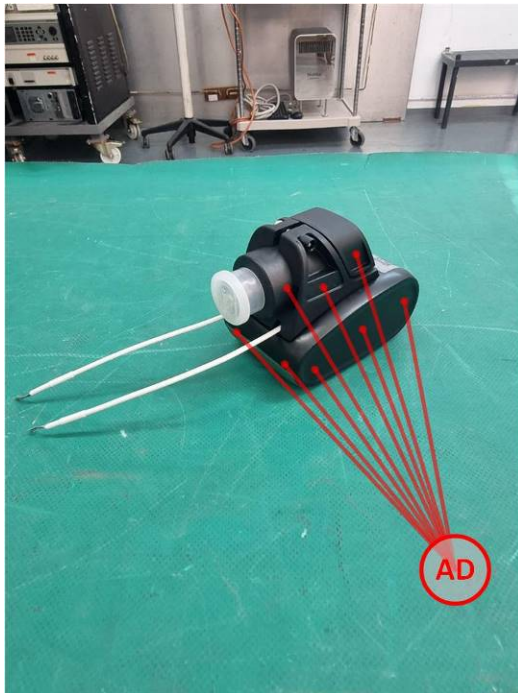
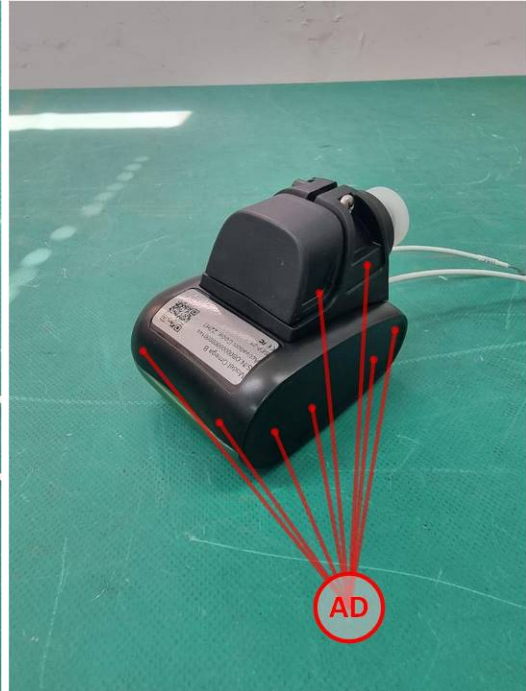
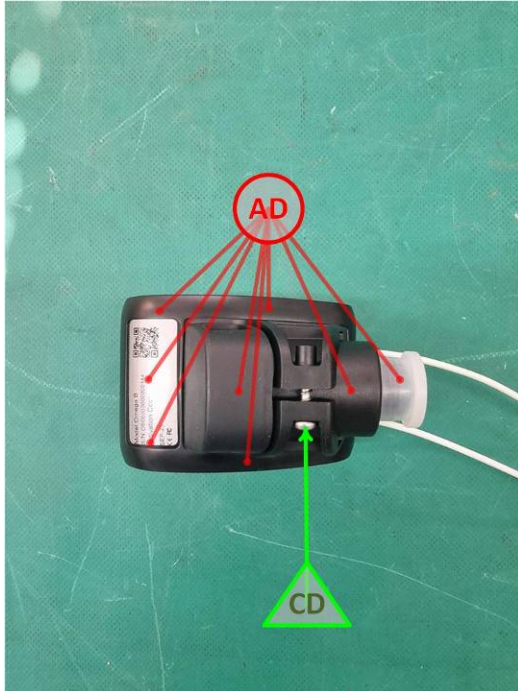



Test specification:	Immunity to electrostatic discharge (ESD)		
Test procedure:	EN 61000-4-2; EN IEC 61326-1, Table 1; EN 301 489-1, Section 9.3		
Test mode:	Compliance	Verdict:	PASS
Date(s):	08-Oct-25		
Temperature: 26 °C	Relative Humidity: 46 %	Air Pressure: 1010 hPa	Power: 3 VDC
Remarks:			

Table 8.1.1 Immunity to ESD test results

EUT SET UP:

TABLE-TOP

PERFORMANCE CRITERIA:

B (EN IEC 61326-1)

TT/TR (EN 301 489-1)

NUMBER OF DISCHARGES AT EACH POINT & EACH LEVEL:

10 POSITIVE / 10 NEGATIVE

ESD applied to	Test voltage, kV	Number of test points	EUT performance description during the test	Verdict
Air discharge				
EUT	2	32*	NP	Pass
	4		NP	
	8		NP	
Contact discharge				
EUT	2	1	NP	Pass
	4		NP	
HCP	2	4	NP	Pass
	4		NP	
VCP	2	4	NP	Pass
	4		NP	

* 10 positive / 10 negative air discharges were applied only to the test points, where discharges occurred. At all other points dielectric was examined for sufficient insulation to prevent disruption.

Reference numbers of test equipment used

HL 3377	HL 2823	HL 4719	HL 4842				
---------	---------	---------	---------	--	--	--	--

Full description is given in Appendix A.



Test specification:	Radiated immunity to radio frequency electromagnetic field		
Test procedure:	EN 61000-4-3; EN IEC 61326-1, Table 1; EN 301 489-1, Section 9.2		
Test mode:	Compliance	Verdict:	PASS
Date(s):	30-Oct-25		
Temperature: 23 °C	Relative Humidity: 41 %	Air Pressure: 1015 hPa	Power: 3 VDC
Remarks:			

8.2 Radiated immunity to radio frequency electromagnetic field

8.2.1 General

This test was performed to verify the EUT immunity to radiated radio frequency electromagnetic field. The radiated RF electromagnetic field levels, performance criterion and test results are referred to in Table 8.2.1.

8.2.2 Test procedure

- 8.2.2.1 The EUT was set up as shown in Figure 8.2.1 and the associated photographs, energized and the EUT performance was checked.
- 8.2.2.2 The electric field generating antenna was installed facing the EUT front panel at the specified distance.
- 8.2.2.3 The test setup was adjusted to produce the required field strength level. The field strength was monitored by the isotropic field probe, which was placed near the EUT.
- 8.2.2.4 The signal frequency was scanned throughout the frequency range.
- 8.2.2.5 The test was performed with the antennas in both vertical and horizontal polarization.
- 8.2.2.6 The test was repeated for the rest of the EUT orientations.
- 8.2.2.7 The EUT operation was monitored throughout the test for any malfunction or degradation and its performance was recorded.
- 8.2.2.8 Upon this the test was completed.

Figure 8.2.1 Setup for radiated immunity to RF electromagnetic field test, table-top EUT

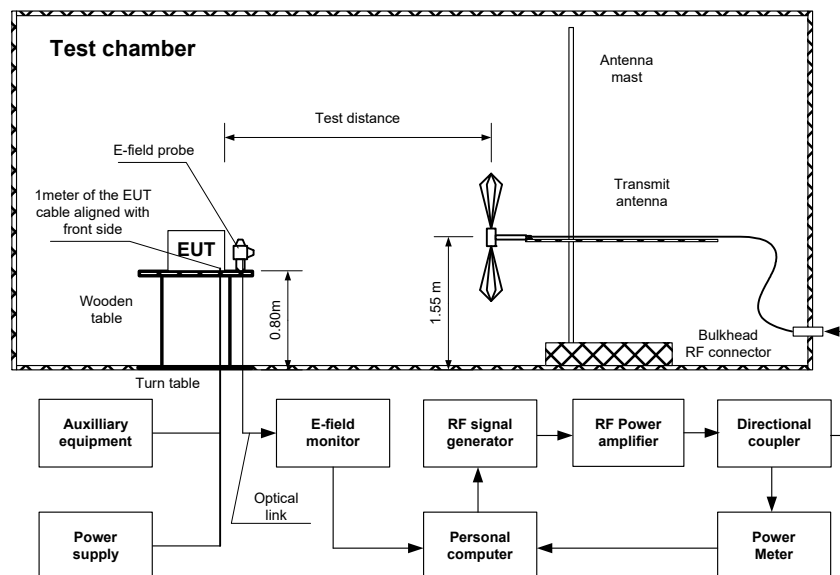



Test specification:	Radiated immunity to radio frequency electromagnetic field		
Test procedure:	EN 61000-4-3; EN IEC 61326-1, Table 1; EN 301 489-1, Section 9.2		
Test mode:	Compliance	Verdict:	PASS
Date(s):	30-Oct-25		
Temperature: 23 °C	Relative Humidity: 41 %	Air Pressure: 1015 hPa	Power: 3 VDC
Remarks:			

Photograph 8.2.1 Setup for radiated immunity to RF electromagnetic field test, general view

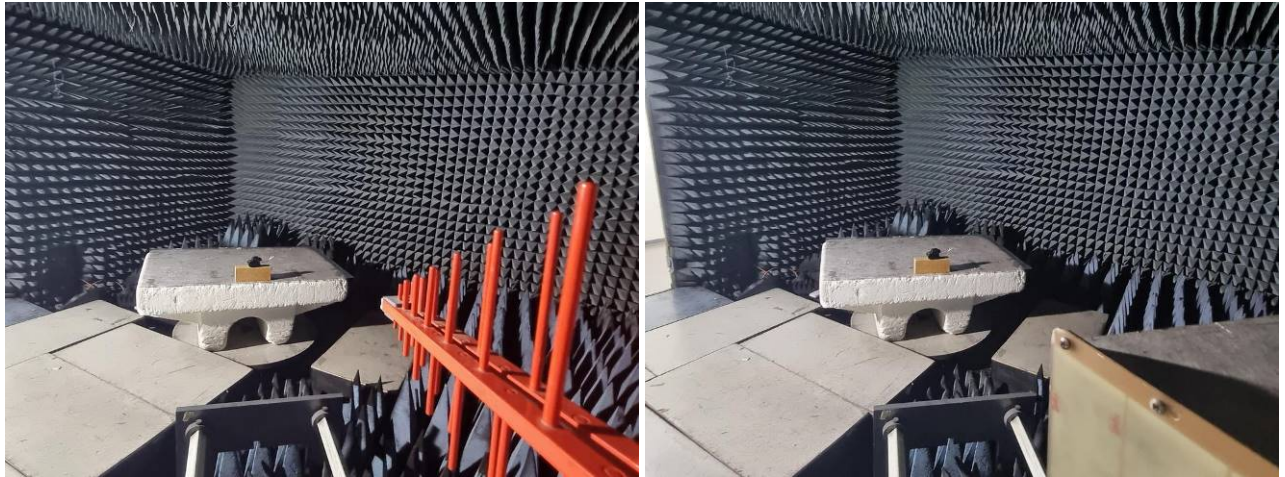

Photograph 8.2.2 Setup for radiated immunity to RF electromagnetic field test, EUT view





Test specification:	Radiated immunity to radio frequency electromagnetic field		
Test procedure:	EN 61000-4-3; EN IEC 61326-1, Table 1; EN 301 489-1, Section 9.2		
Test mode:	Compliance	Verdict:	PASS
Date(s):	30-Oct-25		
Temperature: 23 °C	Relative Humidity: 41 %	Air Pressure: 1015 hPa	Power: 3 VDC
Remarks:			

Table 8.2.1 Radiated immunity to RF electromagnetic field test results

EUT SET UP: TABLE-TOP
PERFORMANCE CRITERIA: A (EN IEC 61326-1)
CT/CR (EN 301 489-1)
TEST SITE: ANECHOIC CHAMBER
ANTENNA TO EUT DISTANCE: 2.4 m
MODULATION: 80% AM with 1 kHz
DWELL TIME: 1 s
FREQUENCY STEP: 1 % of current frequency
FREQUENCY RANGE: 80 – 6000 MHz

EUT orientation*	Antenna polarization	Field strength**, V _{rms} /m	EUT performance description during the test	Verdict
0°	Vertical	3	NP	Pass
	Horizontal		NP	
90°	Vertical		NP	Pass
	Horizontal		NP	
180°	Vertical		NP	Pass
	Horizontal		NP	
270°	Vertical		NP	Pass
	Horizontal		NP	

* - 0° = antenna installed facing the EUT front panel.

** - Field strength measured prior to modulation.

Reference numbers of test equipment used

HL 5673	HL 5668	HL 2697	HL 3025	HL 2432	HL 5396	HL 3158	HL 5896
HL 5942	HL 7821	HL 4277	HL 1629				

Full description is given in Appendix A.



Test specification:	Radiated immunity to power frequency magnetic field		
Test procedure:	EN 61000-4-8; EN IEC 61326-1, Table 1		
Test mode:	Compliance	Verdict:	PASS
Date(s):	12-Oct-25		
Temperature: 23 °C	Relative Humidity: 47 %	Air Pressure: 1009 hPa	Power: 3 VDC
Remarks:			

8.3 Immunity to power frequency magnetic fields

8.3.1 General

This test was performed to verify the EUT immunity to magnetic fields caused by power frequency. The magnetic field levels, performance criterion and test results are referred to in Table 8.3.1.

8.3.2 Test procedure

- 8.3.2.1 The EUT was set up as shown in Figure 8.3.1 and the associated photograph, energized and the EUT performance was checked.
- 8.3.2.2 The test setup was adjusted to produce continuous magnetic field and the EUT was exposed.
- 8.3.2.3 The procedure was repeated for the rest two orthogonal positions of the EUT.
- 8.3.2.4 The EUT operation was monitored throughout the test for any malfunction or degradation and its performance was recorded.
- 8.3.2.5 Upon this the test was completed.

Test specification:	Radiated immunity to power frequency magnetic field		
Test procedure:	EN 61000-4-8; EN IEC 61326-1, Table 1		
Test mode:	Compliance	Verdict:	PASS
Date(s):	12-Oct-25		
Temperature: 23 °C	Relative Humidity: 47 %	Air Pressure: 1009 hPa	Power: 3 VDC
Remarks:			

Figure 8.3.1 Setup for immunity to power frequency magnetic field test

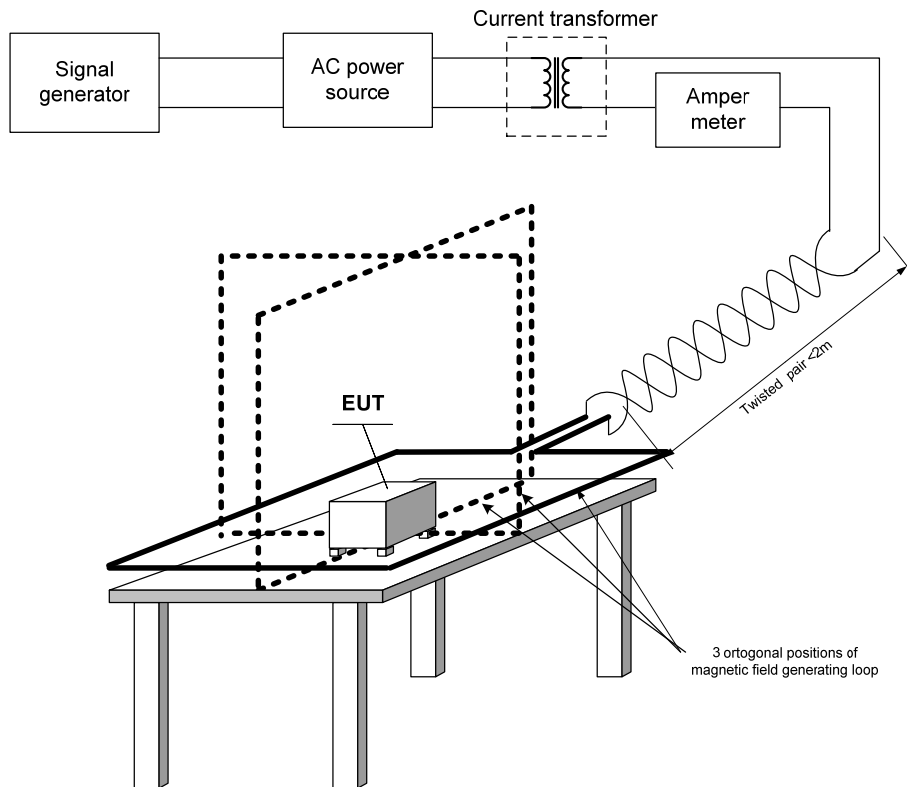

Photograph 8.3.1 Setup for immunity to power frequency magnetic field





Test specification:	Radiated immunity to power frequency magnetic field		
Test procedure:	EN 61000-4-8; EN IEC 61326-1, Table 1		
Test mode:	Compliance	Verdict:	PASS
Date(s):	12-Oct-25		
Temperature: 23 °C	Relative Humidity: 47 %	Air Pressure: 1009 hPa	Power: 3 VDC
Remarks:			

Table 8.3.1 Immunity to power frequency magnetic fields test results

EUT SET UP: TABLE-TOP
PERFORMANCE CRITERIA: A
DURATION: 10 min
MAGNETIC FIELD STRENGTH: 3 A/m
FREQUENCY: 50/60 Hz

EUT orthogonal positions	EUT performance description during the test	Verdict
X	NP	Pass
Y	NP	Pass
Z	NP	Pass

Reference numbers of test equipment used

HL 0133	HL 0926	HL 4952	HL 2489				
---------	---------	---------	---------	--	--	--	--

Full description is given in Appendix A.

9 APPENDIX A Test equipment and ancillaries used for tests

HL No	Description	Manufacturer	Model	Ser. No.	Last Cal./Check	Due Cal./Check
0133	Generator Audio, 5 Hz - 600 kHz	Hewlett Packard	200CDR	60A77719	05-Jan-25	05-Jan-26
0926	Power Source AC, 150/230 VAC	Elgar	751A	479	05-Jan-25	05-Jan-26
1629	Isotropic Field Monitor	Amplifier Research	FM2000	23308	27-Oct-25	27-Oct-26
2432	Antenna, Double-Ridged Waveguide Horn 1 to 18 GHz	EMC Test Systems	3115	00027177	02-Apr-25	02-Apr-26
2489	AC High current generator for magnetic field immunity tests	Hermon Laboratories	MFG-130A	2489	05-Jan-25	05-Jan-26
2697	Antenna, 30 MHz - 3.0 GHz	Sunol Sciences. Corp.	JB3	A022805	13-May-25	13-May-26
2823	ESD generator	Schloder	SESD 30000	509155	21-Oct-25	21-Oct-26
3025	Directional Coupler High Power, 80 to 1000 MHz, 200 W, 40 dB	WERLATONE	C3910	6726	15-Oct-25	15-Oct-26
3158	Amplifier, 80 to 1000 MHz, 500 W	Amplifier Research	500W1000A	0323960	31-Jul-25	31-Jul-26
3377	Resistor for ESD tests EN 61000-4-2 470 kOhm X 2	Hermon Laboratories	R470 x 2	3377	16-Mar-25	16-Mar-26
3903	Microwave Cable Assembly, 40.0 GHz, 1.5 m, SMA/SMA	Huber-Suhner	SUCOFLEX 102A	1226/2A	10-Jun-25	10-Jun-26
4015	Temp. & Humidity Meter, (-50 - +70) deg, (20 - 99)% RH	Mad Electronics	HTC-1	NA	23-Apr-25	23-Apr-26
4277	Test Cable , DC-18 GHz, 3.05 m, N/M - N/M	Mini-Circuits	APC-10FT-NMNM+	0748A	10-Nov-25	10-Nov-26
4360	EMI Test Receiver, 20 Hz to 40 GHz	Rohde & Schwarz	ESU40	100322	23-Jan-25	23-Jan-26
4719	Resistor for ESD tests EN 61000-4-2 470 kOhm X 2	Hermon Laboratories	R470x2	NA	08-Jan-25	08-Jan-26
4842	Coupling Plane Vertical, EN 61000-4-2	Hermon Laboratories	CPV-2	NA	25-Feb-25	25-Feb-26
4933	Active Horn Antenna, 1 GHz to 18 GHz	COM-POWER CORPORATION	AHA-118	701046	19-Feb-25	19-Feb-26
4952	Induction coil according to EN 61000-4-8, 1mx1m	Hermon Laboratories	IC-2	001	16-Jan-23	16-Jan-26
5288	Trilog Antenna, 25 MHz - 8 GHz, 100W	Frankonia	ALX-8000E	00809	08-Apr-25	08-Apr-27
5396	Probe, E-field, isotropic, 0.2 MHz to 26 GHz	General Microwave	84C	210049	25-Nov-24	25-Nov-25
5668	Cable 3, SF126EA/11N(x2)/4.5M, 18 GHz	Huber-Suhner	SF126EA	506763/126EA	14-Sep-25	14-Sep-26
5673	Cable SF126EA/11N(x2)/2M, 18GHz	Huber-Suhner	SF126EA	506756/126EA	25-May-25	25-May-26
5896	Average Power Sensor, 8 kHz to 6.0 GHz	Rohde & Schwarz	NRP6A	103073	28-Jul-25	28-Jul-26
5902	RF cable, 18 GHz, 6.0m, N-type	Huber-Suhner	SF126EA/11N/11N/6000	NA	24-Apr-25	24-Apr-26
5942	Signal Generator, 8.0 kHz to 6.0 GHz	Rohde & Schwarz	SMB-100B	102327	16-Jan-25	16-Jan-26
7821	Single-band Power Amplifier, 380 MHz to 6 GHz, 180W	Rohde & Schwarz	BBA300-CDE180	101338	15-Jan-25	15-Jan-26

10 APPENDIX B Test laboratory description

Tests were performed at Hermon Laboratories Ltd., which is a fully independent, private, EMC, Radio, Safety, Environmental and Telecommunication testing facility.

Hermon Laboratories is recognized and accredited by the Federal Communications Commission (USA) for relevant parts of Code of Federal Regulations 47 (CFR 47), Test Firm Registration Number is 927748, Designation Number is IL1001; Recognized by Innovation, Science and Economic Development Canada for wireless and terminal testing (ISED), ISED #2186A, CAB identifier is IL1001; Certified by VCCI, Japan (the registration numbers for OATS are R-10808 for RE measurements below 1 GHz, G-20112 for RE measurements above 1 GHz, R-11082 for anechoic chamber for RE measurements below 1 GHz, G-10869 for RE measurements above 1 GHz, C-10845 for conducted emissions site and T-11606 for conducted emissions at telecommunication ports).

The laboratory is accredited by American Association for Laboratory Accreditation (USA) according to ISO/IEC 17025 for electromagnetic compatibility, product safety, telecommunications testing, environmental simulation and calibration (for exact scope please refer to Certificate No. 839.01, 839.03 and 839.04).

Address: P.O. Box 23, Binyamina 3055001, Israel.

Telephone: +972 4628 8001

Fax: +972 4628 8277

e-mail: mail@hermonlabs.com

website: www.hermonlabs.com

Person for contact: Mr. Michael Nikishin, EMC&Radio group manager

11 APPENDIX C Abbreviations and acronyms

A	ampere
AC	alternating current
A/m	ampere per meter
AM	amplitude modulation
AVRG	average (detector)
BB	broad band
cm	centimeter
CDN	coupling/ decoupling network
CR	continuous phenomena applied to receivers
CT	continuous phenomena applied to transmitters
dB	decibel
dBm	decibel referred to one milliwatt
dB(μ V)	decibel referred to one microvolt
dB(μ V/m)	decibel referred to one microvolt per meter
dB(μ A)	decibel referred to one microampere
dB Ω	decibel referred to one Ohm
DC	direct current
EMC	electromagnetic compatibility
EMI	electromagnetic interference
EN	European Norm
EUT	equipment under test
GHz	gigahertz
GND	ground
H	height
HCP	horizontal coupling plane
HL	Hermon laboratories
Hz	hertz
k	kilo
kHz	kilohertz
kV	kilovolt
L	length
LISN	line impedance stabilization network
m	meter
MHz	megahertz
min	minute
mm	millimeter
ms	millisecond
μ s	microsecond
NA	not applicable
NB	narrow band
NP	normal performance
NT	not tested
OATS	open area test site
Ω	Ohm
QP	quasi-peak
PM	pulse modulation
PS	power supply
RE	radiated emission
RF	radio frequency
rms	root mean square
s	second
TR	transient phenomena applied to receivers
TT	transient phenomena applied to transmitters
V	volt
VA	volt-ampere
VCP	vertical coupling plane
W	width

12 APPENDIX D Test equipment correction factors

Trilog antenna factor, 25 MHz - 8 GHz, 100W
Frankonia, model ALX-8000E, serial number00809

Frequency (MHz)	Antenna factor (dB/m)
30	14.6
35	14.9
40	16.2
45	17.6
50	17.5
60	16.9
70	13.8
80	10.4
90	13.3
100	15.9
120	13.7
140	12.1
160	12.4
180	13.2
200	15.9
250	16.7
300	17.4
400	19.8
500	21.2
600	22.9
700	23.9
800	25.2
900	26.6
1000	27.0

Antenna factor in dB(1/m) is to be added to receiver meter reading in dB(μ V) to convert it into field intensity in dB(μ V/m).

Horn antenna factor
COM-POWER CORPORATION, Model AHA-118, Serial number 701046

Frequency, MHz	Measured antenna factor, dB/m
1000	-14.58
1050	-16.38
1100	-14.74
1150	-16.16
1200	-15.64
1250	-15.38
1300	-13.84
1350	-14.44
1400	-14.47
1450	-14.29
1500	-15.14
1550	-14.40
1600	-14.18
1650	-14.30
1700	-13.72
1750	-13.03
1800	-12.58
1850	-13.04
1900	-12.83
1950	-12.77
2000	-11.62
2050	-11.81
2100	-11.52
2150	-12.20
2200	-11.90
2250	-12.08
2300	-12.33
2350	-12.44
2400	-12.04
2450	-11.99
2500	-11.87
2550	-11.35
2600	-11.48
2650	-11.25
2700	-10.46
2750	-10.36
2800	-10.34
2850	-10.78
2900	-11.01
2950	-10.95
3000	-11.20
3050	-10.76
3100	-10.39
3150	-10.44
3200	-10.47
3250	-10.81
3300	-10.90
3350	-10.50
3400	-9.85
3450	-10.27
3500	-9.54

Antenna factor in dB(1/m) is to be added to receiver meter reading in dB(μ V) to convert it into field intensity in dB(μ V/m).

Horn antenna factor (continued)
COM-POWER CORPORATION, Model AHA-118, Serial number 701046

Frequency, MHz	Measured antenna factor, dB/m
3550	-9.91
3600	-10.38
3650	-9.72
3700	-9.88
3750	-9.82
3800	-9.51
3850	-9.66
3900	-9.77
3950	-9.97
4000	-9.44
4050	-9.11
4100	-8.34
4150	-7.79
4200	-7.72
4250	-8.18
4300	-8.08
4350	-8.14
4400	-7.85
4450	-7.47
4500	-7.57
4550	-7.34
4600	-7.43
4650	-7.55
4700	-6.83
4750	-6.44
4800	-5.19
4850	-4.90
4900	-4.79
4950	-4.65
5000	-4.86
5050	-4.73
5100	-4.67
5150	-4.22
5200	-3.84
5250	-3.93
5300	-4.25
5350	-4.60
5400	-5.16
5450	-4.91
5500	-4.26
5550	-3.07
5600	-3.15
5650	-3.16
5700	-3.59
5750	-3.34
5800	-3.82
5850	-3.75
5900	-3.86
5950	-3.56
6000	-3.63

Antenna factor in dB(1/m) is to be added to receiver meter reading in dB(μ V) to convert it into field intensity in dB(μ V/m).

13 APPENDIX E Measurement uncertainties

Expanded uncertainty at 95% confidence in Hermon Labs EMC measurements

Test description	Expanded uncertainty
Conducted emissions at mains port with LISN and HP 8542E or HP 8546A receiver	9 kHz to 150 kHz: ± 3.9 dB 150 kHz to 30 MHz: ± 3.8 dB
Conducted emissions at telecommunication port with HP 8542E or HP 8546A receiver	ISN: ± 3.3 dB Current probe: ± 3.5 dB
Radiated emissions at 10 m measuring distance Horizontal polarization Vertical polarization	Biconilog antenna: ± 5.0 dB Biconical antenna: ± 5.0 dB Log periodic antenna: ± 5.1 dB Double ridged horn antenna: ± 5.3 dB Biconilog antenna: ± 5.5 dB Biconical antenna: ± 5.5 dB Log periodic antenna: ± 5.6 dB Double ridged horn antenna: ± 5.8 dB
Radiated emissions at 3 m measuring distance Horizontal polarization Vertical polarization	Biconilog antenna: ± 5.3 dB Biconical antenna: ± 5.0 dB Log periodic antenna: ± 5.3 dB Double ridged horn antenna: ± 5.3 dB Biconilog antenna: ± 6.0 dB Biconical antenna: ± 5.7 dB Log periodic antenna: ± 6.0 dB Double ridged horn antenna: ± 6.0 dB
Harmonic current	$\pm 4.0\%$
Voltage fluctuations and flickers	$\pm 5.3\%$
ESD	It has been demonstrated that calibration results are within the limits specified in the EN 61000-4-2 standard reduced by uncertainty of calibration that prove compliance with standard requirements with at least a 95% confidence. Parameters that have been calibrated and tolerances are shown below: First peak current of discharge: $\pm 10\%$ (refer to standard Table 2) Current at 30 ns: $\pm 30\%$ (refer to standard Table 2) Current at 60 ns: $\pm 30\%$ (refer to standard Table 2) Rise time: 0.7 – 1 (ns)
Radiated immunity AR FP2000 E-field probe AR FP2080 E-field probe	10 kHz to 250 MHz: ± 1.9 dB; 250 MHz to 1 GHz: ± 2.1 dB 80 MHz to 26 GHz: ± 2.7 dB; 26 GHz to 40 GHz: ± 4.0 dB
Conducted RF immunity - CDN injection - Current probe injection - Direct injection	± 1.3 dB ± 3.1 dB ± 3.1 dB

Test description	Expanded uncertainty																				
EFT - CDN injection - Capacitive clamp injection	<p>It has been demonstrated that calibration results are within the limits specified in the EN 61000-4-4 standard reduced by uncertainty of calibration, that prove compliance with standard requirements with at least a 95% confidence.</p> <p>Parameters that have been calibrated and tolerances are shown below: Peak voltage: (0.125 to 2 kV) $\pm 10\%$ at 50 Ω Peak voltage: (0.24 to 3.8 kV) $\pm 10\%$ at 1000 Ω Rise time: 5 ns $\pm 30\%$ at 50 Ω / 5 ns $\pm 30\%$ at 1000 Ω Crest time: 50 ns $\pm 30\%$ at 50 Ω / 50 ns -15 ns / +100 ns at 1000 Ω Burst duration: 15 ms $\pm 20\%$ at 5 kHz / 0.75 ms $\pm 20\%$ at 100 kHz Burst period: 300 ms $\pm 20\%$ Repetition frequency: 5 or 100 kHz $\pm 20\%$ Peak voltage at CDN output: (0.125 to 2 kV) $\pm 10\%$ at 50 Ω under 4 kV Rise time at CDN output: 5 ns $\pm 30\%$ at 50 Ω under 4 kV Crest time at CDN output: 50 ns $\pm 30\%$ at 50 Ω under 4 kV</p>																				
High voltage surges	<p>It has been demonstrated that calibration results are within the limits specified in the EN 61000-4-5 standard reduced by uncertainty of calibration, that prove compliance with standard requirements with at least a 95% confidence.</p> <p>Parameters that have been calibrated and tolerances are shown below: 1.2/50 μs combination wave generator: Open-circuit output voltage: (0.5 to 6 kV) $\pm 10\%$ Short-circuit output current: (0.25 to 3 kA) $\pm 10\%$ Effective output impedance: 2 Ω $\pm 10\%$ Phase shifting: 0 to 360° $\pm 10^\circ$ Undershoot: < 30% of the output voltage</p> <table border="0" data-bbox="678 1008 1500 1131"> <tr> <td>Coupling:</td> <td>Direct</td> <td>18 μF</td> <td>9 μF+10 Ω</td> </tr> <tr> <td>Open-circuit front time:</td> <td>1.2 μs $\pm 30\%$</td> <td>1.2 μs $\pm 30\%$</td> <td>1.2 μs $\pm 30\%$</td> </tr> <tr> <td>Open-circuit time to half-value:</td> <td>50 μs $\pm 20\%$</td> <td>50 μs ± 10 μs</td> <td>50 μs +10/-25 μs</td> </tr> <tr> <td>Short-circuit front time:</td> <td>8 μs $\pm 20\%$</td> <td>8 μs $\pm 20\%$</td> <td>2.5 μs $\pm 30\%$</td> </tr> <tr> <td>Short-circuit time to half-value:</td> <td>20 μs $\pm 20\%$</td> <td>20 μs $\pm 20\%$</td> <td>25 μs $\pm 30\%$</td> </tr> </table> <p>10/700 μs combination wave generator: Open-circuit output voltage: (0.5 to 6 kV) $\pm 10\%$ Short-circuit output current: (12.5 A to 150 A) $\pm 10\%$ Effective output impedance: 40 Ω $\pm 10\%$ Open-circuit front time: 10 μs $\pm 30\%$ Open-circuit time to half-value: 700 μs $\pm 20\%$ Short-circuit front time: 5 μs $\pm 20\%$ Short-circuit time to half-value: 320 μs $\pm 20\%$</p>	Coupling:	Direct	18 μ F	9 μ F+10 Ω	Open-circuit front time:	1.2 μ s $\pm 30\%$	1.2 μ s $\pm 30\%$	1.2 μ s $\pm 30\%$	Open-circuit time to half-value:	50 μ s $\pm 20\%$	50 μ s ± 10 μ s	50 μ s +10/-25 μ s	Short-circuit front time:	8 μ s $\pm 20\%$	8 μ s $\pm 20\%$	2.5 μ s $\pm 30\%$	Short-circuit time to half-value:	20 μ s $\pm 20\%$	20 μ s $\pm 20\%$	25 μ s $\pm 30\%$
Coupling:	Direct	18 μ F	9 μ F+10 Ω																		
Open-circuit front time:	1.2 μ s $\pm 30\%$	1.2 μ s $\pm 30\%$	1.2 μ s $\pm 30\%$																		
Open-circuit time to half-value:	50 μ s $\pm 20\%$	50 μ s ± 10 μ s	50 μ s +10/-25 μ s																		
Short-circuit front time:	8 μ s $\pm 20\%$	8 μ s $\pm 20\%$	2.5 μ s $\pm 30\%$																		
Short-circuit time to half-value:	20 μ s $\pm 20\%$	20 μ s $\pm 20\%$	25 μ s $\pm 30\%$																		
Power frequency magnetic field immunity	± 2.5 dB																				
Voltage dips, short interruptions and variations	<p>It has been demonstrated that calibration results are within the limits specified in the EN 61000-4-11 standard reduced by uncertainty of calibration, that prove compliance with standard requirements with at least a 95% confidence.</p> <p>Parameters that have been calibrated and tolerances are shown below: Open-circuit voltage: $\pm 5\%$ Voltage change under full load: Nominal voltage: $\pm 5\%$ 70% of nominal voltage: $\pm 7\%$ 40% of nominal voltage: $\pm 10\%$</p>																				
Immunity to electrical transient	$\pm 6.96\%$																				

Hermon Laboratories is accredited by A2LA for calibration according to present requirements of ISO/IEC 17025 and NCSL Z540-1. The accreditation is granted to perform calibration of parameters that are listed in the Scope of Hermon Laboratories Accreditation.

Hermon Laboratories calibrates its reference and transfer standards by calibration laboratories accredited to ISO/IEC 17025 by a mutually recognized Accreditation Body or by a recognized national metrology institute. All reference and transfer standards used in the calibration system are traceable to national or international standards.

In-house calibration of all test and measurement equipment is performed on a regular basis according to Hermon Laboratories calibration procedures, manufacturer calibration/verification procedures or procedures defined in the relevant standards. The Hermon Laboratories test and measurement equipment is calibrated within the tolerances specified by the manufacturers and/or by the relevant standards.

14 APPENDIX F Specification references

EN IEC 61326-1: 2021	Electrical equipment for measurement, control and laboratory use - EMC requirements – Part 1: General requirements
EN 301 489-17 V3.3.1: 2024	ElectroMagnetic Compatibility (EMC) standard for radio equipment and services; Part 17: Specific conditions for Broadband and Wideband Data Transmission Systems; Harmonised Standard for ElectroMagnetic Compatibility
EN 301 489-52 V1.3.1: 2024	ElectroMagnetic Compatibility (EMC) standard for radio equipment and services. Part 52: Specific conditions for Cellular Communication User Equipment (UE) radio and ancillary equipment; Harmonised Standard for ElectroMagnetic Compatibility
EN 301 489-1 V2.2.3: 2019	ElectroMagnetic Compatibility (EMC) standard for radio equipment and services; Part 1: Common technical requirements; Harmonised Standard for ElectroMagnetic Compatibility
EN 55032: 2015	Electromagnetic compatibility of multimedia equipment — Emission requirements
CISPR 11: 2015 + A1(16) + A2(19)	Industrial, scientific and medical (ISM) radio-frequency equipment-electromagnetic disturbance characteristics. Limits and methods of measurement
CISPR 14-1: 2005+A1(08)+A2(11)	Electromagnetic compatibility – Requirements for household appliances, electric tools and similar apparatus – Part 1: Emission
CISPR 16-1-1: 2019	Specification for radio disturbance and immunity measuring apparatus and methods. Part 1-1: Radio disturbance and immunity measuring apparatus – Measuring apparatus
CISPR 16-2-1: 2014 + A1(17)	Specification for radio disturbance and immunity measuring apparatus and methods. Part 2-1: Methods of measurement of disturbances and immunity – Conducted disturbance measurements
CISPR 16-2-3: 2016 + A1(19)	Specification for radio disturbance and immunity measuring apparatus and methods. Part 2-3: Methods of measurement of disturbances and immunity – Radiated disturbance measurements
EN IEC 61000-3-2: 2019 + A1(21)	Electromagnetic compatibility (EMC) - Part 3: Limits. Section 2. Limits for harmonic current emissions for equipment with input current <16 A
EN 61000-3-3: 2013 + A1(19)	Electromagnetic compatibility (EMC) - Part 3: Limits. Section 3: Limitation of voltage fluctuations and flicker in low-voltage supply systems for equipment with rated current <16 A
EN 61000-4-2: 2009	Electromagnetic compatibility (EMC). Part 4: testing and measurement techniques. Section 2: Electrostatic discharge immunity test
EN 61000-4-3: 2006+A1(08)+A2(10)	Electromagnetic compatibility (EMC). Part 4: testing and measurement techniques. Section 3: Radiated, radio frequency, electromagnetic field immunity test
EN 61000-4-4: 2012	Electromagnetic compatibility (EMC). Part 4: testing and measurement techniques. Section 4: Electrical fast transient/burst immunity test
EN 61000-4-5: 2014	Electromagnetic compatibility (EMC). Part 4: testing and measurement techniques. Section 5: Surge immunity test
EN 61000-4-6: 2014	Electromagnetic compatibility (EMC) Part 4: testing and measurement techniques. Section 6: Immunity to conducted disturbances, inducted by radio-frequency fields
EN 61000-4-11: 2004	Electromagnetic compatibility (EMC). Part 4: testing and measurement techniques Section 11: Voltage dips, short interruptions and voltage variations immunity test
EN 61000-4-8: 2010	Electromagnetic compatibility (EMC). Part 4: testing and measurement techniques. Section 8: Power - frequency magnetic field immunity test
ISO 7637-2: 2004	Road vehicles – Electrical disturbance from conduction and coupling. Part 2: Electrical transient conduction along supply lines only

END OF TEST REPORT

15 APPENDIX G Manufacturer's declaration

Note: The following data in this clause is provided by the customer and represents his sole responsibility.



Declaration of Identity

We, the undersigned,

Company: Bermad CS. Ltd

Address: Kibbutz Evron

Country: Israel

Telephone number: +972-73-2655311

Fax number: +972-73-2655356

Declare under our sole responsibility, the equipment below is electronically/electrically/mechanically similar except the following:

Brand	Type/Model	Short Product description
BERMAD	Omega B	Irrigation controller with Bermad's solenoid model S392
	Omega G	Irrigation controller compatible with any DC Latch solenoid

The tested model Omega B represents the worst-case configuration for compliance testing

Authorized Signatory,

Ronit Mendel-Assor

Standards & IP Associate



Date: 23-Nov-25

BERMAD Evron, 2280800, Israel
Tel: +972-73-2655311 • Fax: +972-73-2655356 • www.bermad.com

END OF DOCUMENT

