

AIR CONTROL IN WATER SYSTEMS

A GUIDE FOR SYSTEM DESIGNERS

This guide offers tools for planning air control, selection and specifications of air valves.

TABLE OF CONTENT

Company Profile	3
Chapter 1 Principles of Air Control in pressurized water systems	7
Chapter 2 Air Valves benefits and Air Valves types	9
Chapter 3 Air Valves principles of operation	11
Chapter 4 WaterWorks & Buildings typical applications	13
Chapter 5 Air Valves locations	14
Chapter 6 Air Valve sizing principles	19
Chapter 7 BERMAD AIR - Sizing & positioning software	20
Chapter 8 Preliminary sizing graphs	24
Chapter 9 Surge analysis	26
Chapter 10 Air Valves specifications	28
Chapter 11 Installation considerations	29
Chapter 12 BERMAD air flow test bench for air valves	31
Chapter 13 BERMAD Air Valves – Why they are better for your system	32
Chapter 14 BERMAD Air Valves certifications	33
Chapter 15 BERMAD Air Valves product matrix	34
Bermad Disclaimer	35



Company Profile

BERMAD is a leading, privately-owned global company that designs, develops and manufactures tailor-made water & flow management solutions that include state-of-the-art hydraulic control valves, air valves and advanced metering solutions.

Founded in 1965, we have spent over 50 years interacting with the world's major end users, and accumulating knowledge and experience in multiple markets and industries. Today, we are recognized as a pioneer and established world-leading provider of water & flow management solutions that give our customers the unprecedented operational efficiency, and superior quality, durability and performance they need to meet the demanding challenges of the 21st century.

Customized for the unique needs of multiple sectors

Incorporating advanced water & flow management capabilities, our best-of-breed solutions have been carefully customized to meet the unique needs of multiple sectors and industries.



Innovation



Integrity



Commitment



Quality



Professionalism



Irrigation

Our vision is to provide integrated irrigation management solutions. To this end, we continuously develop our team capabilities to acquire the deepest practical knowledge. We strive to be a "one-stop shop" for our customers by designing, manufacturing and providing support for the widest range of innovative water flow management products that are integrated into efficient and cost-effective solutions for the full range of agricultural irrigation needs.

Fire Protection

Our globally-proven fire protection solutions incorporate unique, patented technologies for fail-safe, minimum flow obstruction and high-resistance to water hammer and surge. Providing the greatest reliability over the longest service life, these high-quality solutions can be found throughout the world as vital components of fire protection systems, including high-hazard areas and installations that require unique solutions – helping to save lives and prevent property damage in fire events. BERMAD fire protection valves meet the most demanding industry standards.



Buildings & Construction

The Buildings & Construction industry has unique requirements, which, together with their fire protection requirements, must be taken into account when designing and installing their water supply and distribution systems. For this reason, our water & control management solutions for the Building & Construction industry are designed and manufactured with careful consideration for important issues such as constant water supply, noise and maintenance considerations, sanitary and safety, integration and control and high water consumption.

Waterworks

As pioneers in water supply protection and efficiency, our proven water & control management solutions include state-of-the-art hydraulic control valves, air valves and advanced water meters. Whether for bulk water supply systems, water distribution network grids, or waste water pumping stations and delivery lines, we offer robust and reliable solutions that help optimize water usage, maximize energy efficiency, reduce costs, protect water supply and distribution systems, and keep water system downtime to a minimum.



Mining

Our comprehensive range of custom-made, high-performance and proven control valves, air valves and surge protection devices are widely deployed in the mining industry worldwide, providing solutions for the toughest flow control applications in copper, gold, iron, coal and other precious metal mines.

BERMAD WORLDWIDE

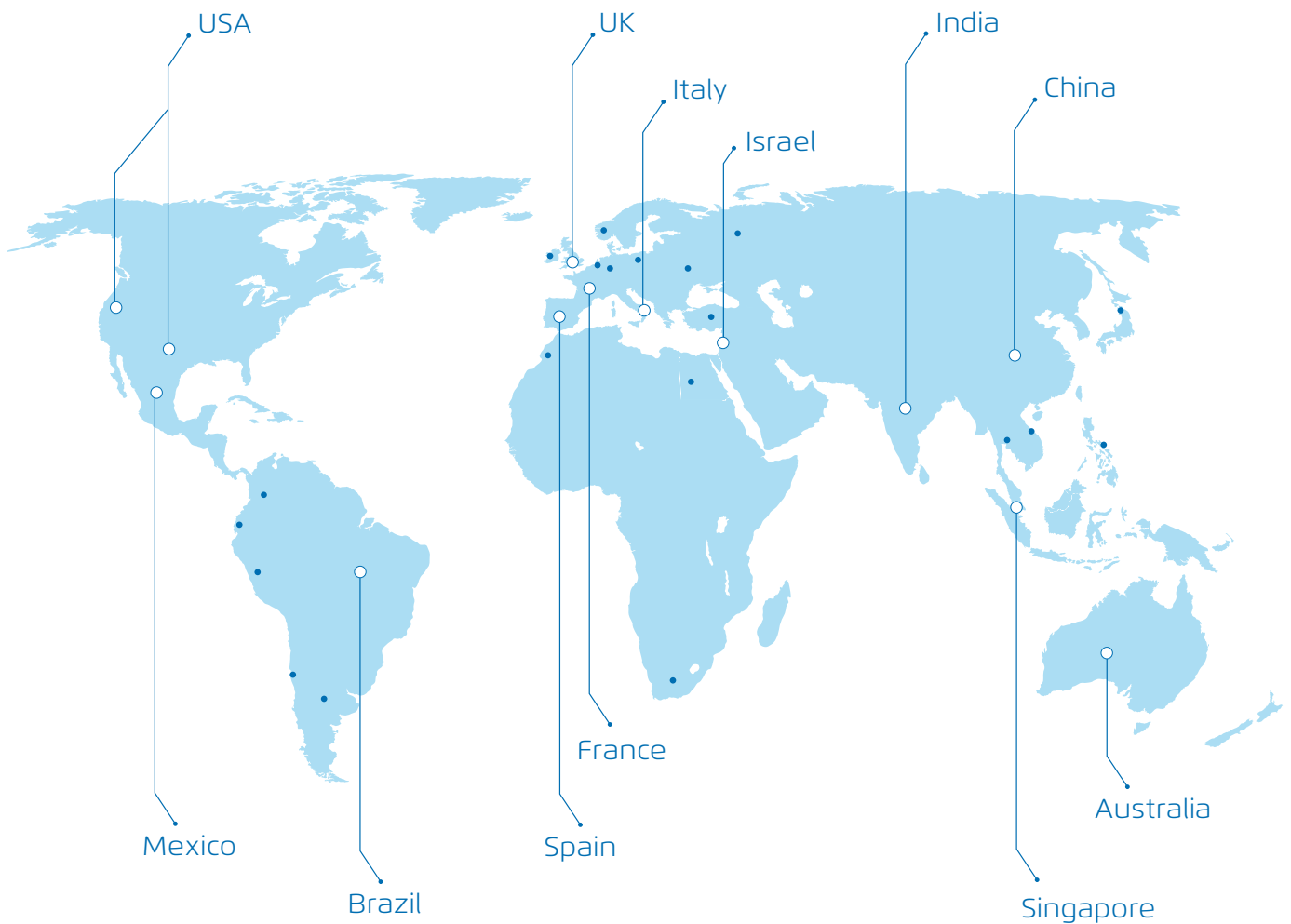

Operating globally for your peace of mind

Our extensive global network works together to offer our customers exceptional service and peace of mind. With 12 globally-dispersed subsidiaries and distributors or a direct presence in over 85 countries, we have built a reputation of top-quality sales and after-sales service supported by highly-trained and dedicated professionals.

This enables us to make a significant contribution in the world arena, and to take part in multiple large-scale international projects. From the Channel Tunnel to the 3 Gorges Dam in China, and from the irrigation fields of Asia and South America to the oil fields of the North Sea and the Persian Gulf, governments and private sector partners around the world rely on our solutions for all their water & flow management needs.



Dedicated to precision engineering and ongoing support

With an understanding that comprehensive water flow management solutions are only as effective as their smallest component, we design, develop and manufacture all hydraulic control valves, air valves and advanced metering solutions in-house according to the most stringent quality procedures.

This dedication to innovation, precision, quality and reliability enables us to adapt and customize our solutions to meet almost any customer need; to constantly integrate the latest and most reliable manufacturing techniques into our processes; and to provide every customer with excellent comprehensive commercial and technical support before, during and after installation.

Helping to manage the world's most precious resource

At BERMAD, we understand that the efficient and smart management of our planet's most precious resource is as vital as the resource itself.

This underpins our commitment to designing, manufacturing and supplying water & flow management solutions that help reap the full benefits of every single drop of water.

Our dedication to our customers is matched by our commitment to the environment. In addition to offering comprehensive solutions that maximize the usage efficiency of water and other resources, we are constantly searching for new and better manufacturing materials and methods to ensure sustainability. As a result, our products comply with the most stringent international environmental standards and certifications.

Chapter 1 - Principles of Air Control in pressurized water systems

Introduction

The presence of uncontrolled quantities of air in water systems can seriously affect their performance, causing inefficient filling and draining procedures and flow reduction, while increasing energy costs. It also disrupts the operation of some of the system’s components. On the other hand, air is essential in dealing with vacuum conditions and pressure surges. Effective control of air in a water network is based on evaluating the required air volume during various modes of operation, and according to the required volume, the proper positioning and sizing of the air valves.

Air control in pressurized water systems is critical for increasing efficiency during filling, draining and pressurized operation, as well as to protect them from vacuum conditions and pressure surge.

Sources of air in water systems

There are various sources to the presence of air in water systems:

- At the starting point, when the system is empty, it is being filled with air.
- All liquids contain dissolved air. The volume of the dissolved air depends on pressure and temperature; it is around 2% at atmospheric pressure and a temperature of 25°C, 77°F.

In pressurized systems, the pressure varies along the pipeline, according to the Hydraulic Grade Line (HGL) and pipeline profile. At points where the pressure drops, the dissolved air is transformed into air bubbles, which will accumulate to air pockets in the system.

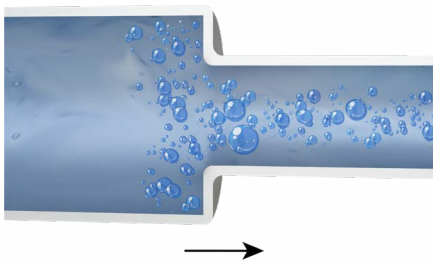

Picture 1.1 – Creation of air bubbles

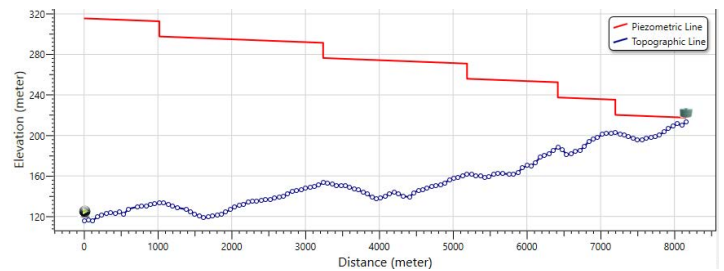

Picture 1.2 - Entrapped air pockets increase head losses

- Turbulent flow will create a mixture of air and water downstream of the reservoirs and further into the line.
- Centrifugal pumps promote vortex formation allowing large quantities of air into the system.
- In municipal sewage systems, air bubbles are also generated by microbiological activity.

Significance of air in water systems

The significance of air in water systems is different in each of their various operating modes

■ Pipeline filling:

To allow efficient filling, air has to be relieved or evacuated. In case the air is not being effectively relieved, the pipeline filling time will increase significantly. A large volume of air, which was not relieved during pipeline filling, might lead to pressure surges.

■ Pressurized operation (Steady State):

Air bubbles will accumulate at the higher points in the system, and gradually reduce the effective cross section of the pipe. The result will be reduction in flow and increased energy costs (to maintain the design flow).

In extreme cases, the pump will be unable to supply the required extra pressure needed to overcome the air pockets and flow in the system might completely stop. [Click to watch Animation.](#)



Picture 1.3 - Air bubbles create entrapped air pockets

In addition, air disturbs the operation components such as pumps, regulating valves and filters. Mechanical water meters, whose readings are based on liquid velocity, will provide inaccurate readings due to the presence of air in the meter. Also the presence of air in high volumes in the system will contribute to enhance corrosion in metal pipelines.

■ **Pipeline draining:**

During system draining, whether due to burst or maintenance, negative pressures (Vacuum Conditions) will be created. Negative pressures may damage different components and under severe conditions can lead to pipeline collapse. Allowing air intake will eliminate negative pressures and protect the system. [Click to watch Animation.](#)

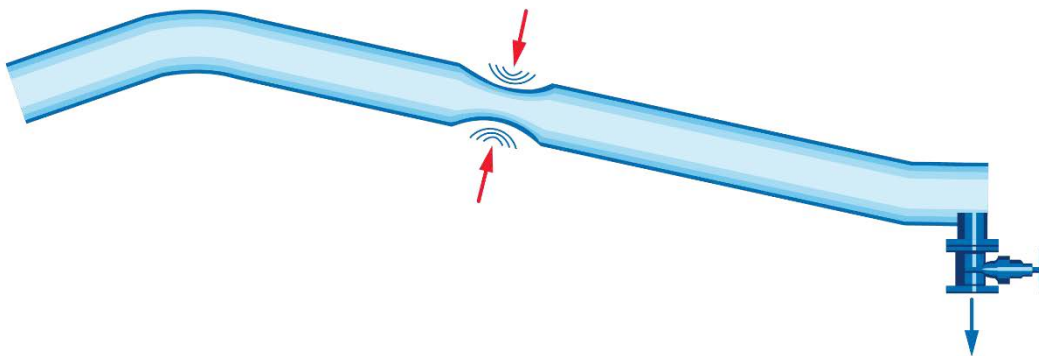

Picture 1.4 - Negative pressure during pipeline draining

In addition, since negative pressure creates suction into the system from the atmosphere.

In potable water systems, where devices are installed in underground chambers, entrance of contaminated water can be a major problem.

In drip irrigation systems, dirt and soil may enter the system and clog the drippers' nozzles.

■ **Pressure surge (Water Hammer):**

Pressure surges may be a result of pump trip, fast valve closure and more. It is likely, that in the same magnitude the pressure rises, it will also drop. In some cases, pressure becomes negative (Vacuum Conditions), and in worst cases water column separation may occur, along with cavity formation.

Without a proper control of the surge pressure, the system may suffer significant damages. Neutralizing the Vacuum Conditions will require air intake at critical points, based on Surge Analysis. [Click to watch Animation.](#)

Chapter 2 – Air Valves benefits and Air Valves types

Benefits of Using Air Valves

Stage	Air Valve's Function	Benefits
Pipeline filling	Air relief	Increase system efficiency and shorten filling time Click to watch Animation.
Pipeline draining or burst	Air intake	Protection from vacuum conditions and pipe collapse Click to watch Animation.
Pressurized operation	Air release (entrapped air pockets)	Increase system efficiency, save energy and pumping cost
	Air release (air bubbles)	Prevents false readings by water meters Prevents malfunction of regulation devices and filters
Water hammer (Surge pressure)	Air intake, air relief	Protection from vacuum conditions Controlled & safe air relief Click to watch Animation.

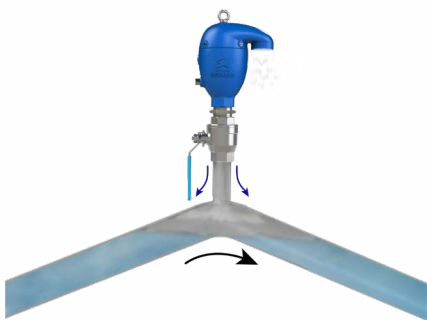

Picture 2.1 - Air intake



Picture 2.2 - Releasing entrapped air pockets

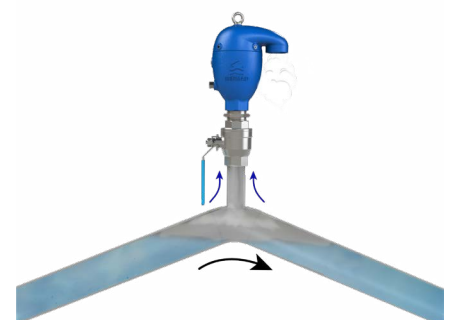

Picture 2.3 - Air relief

Types of Air Valves

There are 3 basic types of Air Valves:

- **Automatic Air Valve (Air Release):**

The valve releases entrapped air pockets during pressurized operation. It has one single small orifice, called the Automatic Orifice, in diameters of 0.04 - 0.2 inch; 1 - 5 mm.

- **Kinetic Air valve (Air Relief/Intake):**

The valve evacuates air during pipeline filling and enables air intake in the event of system draining or vacuum conditions. It has one single large orifice, called the Kinetic Orifice, in diameters of 1 - 10 inch; 25 - 250 mm. A Kinetic Air Valve, which is restricted only to air intake, is also known as Vacuum Breaker.

- **Combination Air Valve:**

The valve combines the function of Automatic and Kinetic Air Valves. It evacuates air during pipeline filling, allows efficient release of air pockets from pressurized pipes, and enables air intake in the event of network draining or vacuum conditions. It has two orifices – Automatic and Kinetic. [Click to watch Animation.](#)

Air Valves are also classified by the type of water:

- **Air valves for Clean Water:**

To be used with drinking water, irrigation water, reused or recycled water.

- **Air valves for Non Clean Water:**

To be used with unclean waters, for example, municipal sewage, industrial and mining systems. Their function is the same as that of the Clean Water Air Valves; however, the main difference lies in their elongated body and internal parts designed to keep the water apart from the valve mechanism.

Additional Features for Air Valves

- **Surge Protection - SP (Non-slam):**

Designed for partially close the kinetic orifice during air relief. It prevents the slam/shock resulting from a rapid closure of the kinetic orifice during pipeline filling or water column separation. The Surge Protection feature ensures smoother operation and prevents damage to the air valve or system. [Click to watch Animation.](#)

- **Assisted Closing - AC:**

This feature is similar to SP, but in this case the SP disc is held upwards using a spring. It means that, regardless of inline pressure, outflow is only through the SP disc (switching value = 0).

- **Inflow Prevention - IP:**

Prevents intake of atmospheric air in cases where this could lead to damaged pumps, required re-priming, or disruption of siphons. It also prevents intake of flood or polluted water into drinking water networks.



Picture 2.4 - Combination Air valves with an addition feature of Surge Protection (SP) disc.



Picture 2.5 - Combination Air valves with an addition feature of Assisted Closing (AC) disc.



Picture 2.6 - Combination Air valves with an addition feature of Inflow Prevention (IP).

Chapter 3 – Air Valves principles of operation

Pipeline Filling

During the filling process of a pipeline, a high volume of air is being forced out through the kinetic orifice of the air valve. Once water enters the valve body, the float buoys upwards, causing the kinetic orifice to close.

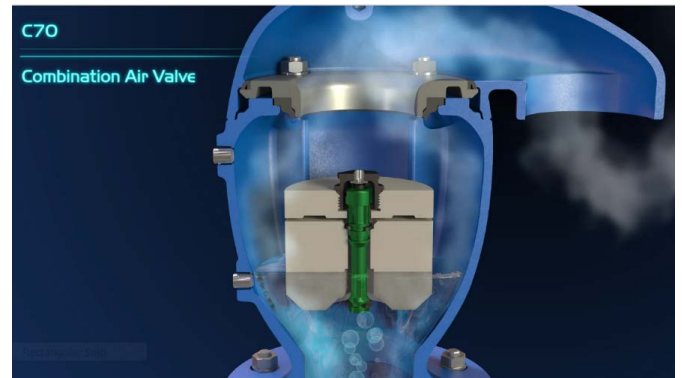

Picture 3.1 - C70, Air relief during pipeline filling

[Click to watch C70 Principle of Operation Animation](#)

Pressurized Operation (Steady State)

During pressurized operation of the pipeline, air bubbles accumulate in the upper part of the air valve body, causing the float to gravitate downwards.

This in turn causes the automatic orifice to open, releasing the accumulated air. As the air has been discharged, the water level and float will rise, causing the automatic orifice to close.

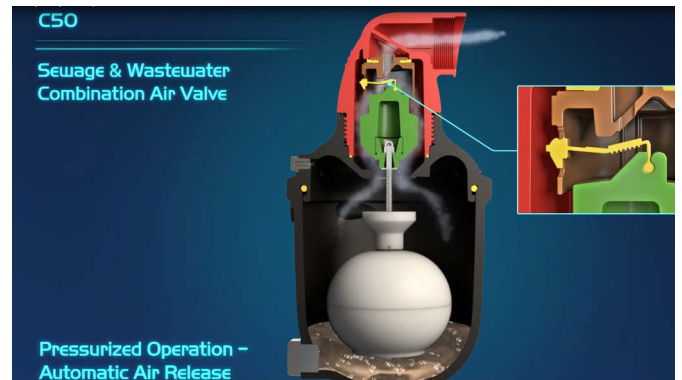

Picture 3.2 – C50, Automatic Air Release

[Click to watch C50 Principle of Operation Animation](#)

In BERMAD's C70 and C75 models, the automatic orifice opens in a two-step action, forming an air gap between the water level and the automatic orifice and only then releasing the accumulated air, while minimizing the spray effect. As the air has been discharged, the water level and float will rise, causing the automatic orifice to close.

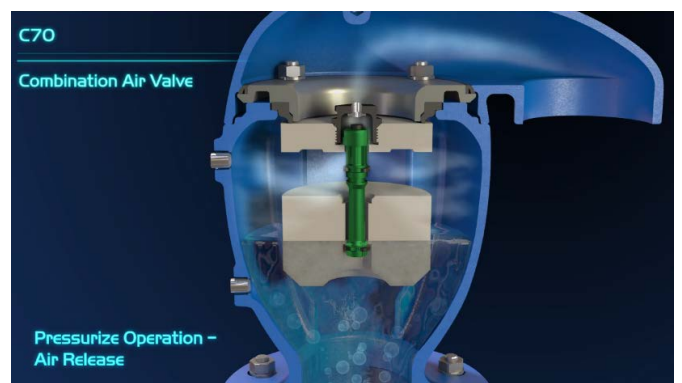

Picture 3.3 -

C70, Automatic Air Release with a two-step action

[Click to watch C70 Principle of Operation Animation](#)

**Vacuum conditions
(Burst, Drainage, Negative pressure surge)**

Whenever the pipeline is being drained, such as following a burst, a negative pressure (Vacuum) might be created. The kinetic orifice opens to draw large volume of atmospheric air into the pipeline, thus preventing vacuum formation.



Picture 3.4 C30, Air intake during vacuum conditions

[Click to watch C30 Principle of Operation Animation](#)

Surge Protection Feature (Non-Slam)

In case of the pipeline filling at high velocity, or in the event of a pressure surge, the Surge Protection (SP) disc rises (at an air relief pressure of around 7 psi; 0.05 bar) partially closing the valve’s orifice. The approaching water decelerates due to the resistance of the rising air pressure in the valve and pipe, e.g prevent air valve slamming.

BERMAD’s C70 and C75 models have also an Assisted Closing (AC) feature. It is similar to the Surge Protection (SP) feature, but the disc is pulled up to the kinetic Orifice by a spring. This means the kinetic orifice is always partially closed.

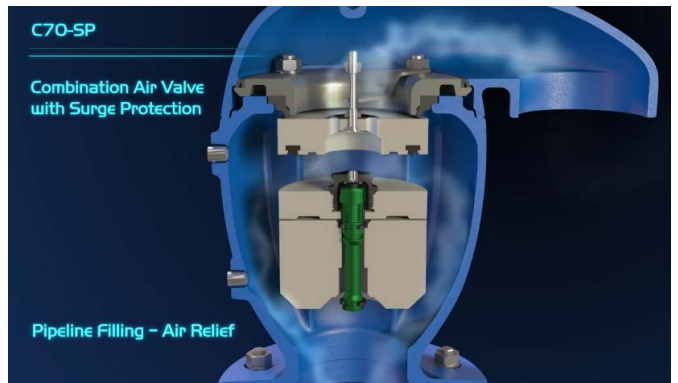

Picture 3.5 – C70, Air relief with Surge Protection (SP)

[Click to watch C70 Principle of Operation Animation](#)

BERMAD’s C10, C30 and C50 models have a Surge Protection mechanism, based on a flexible seal that partially closes the valve outlet with the increase of air relief.

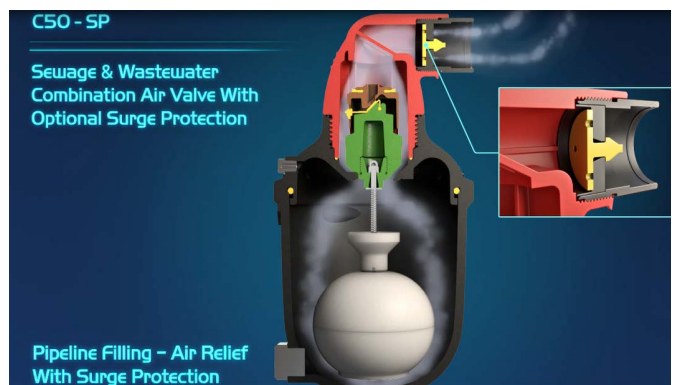

Picture 3.6 – C50, Air relief with Surge Protection (SP) based on a Seal.

Inflow prevention feature

The inflow prevention mechanism is a Normally Closed assembly mounted on the top of the valve kinetic orifice (BERMAD’s C70, C75 models) or threaded to the valve outlet (BERMAD’s C10, C30 & C50 models) to prevent atmospheric air from entering the valve.



Picture 3.7 C70 with Inflow Prevention feature



Picture 3.8 C30 with Inflow Prevention feature

Chapter 4 – Typical Applications

Water Works



Picture 4.1 - Pumping station

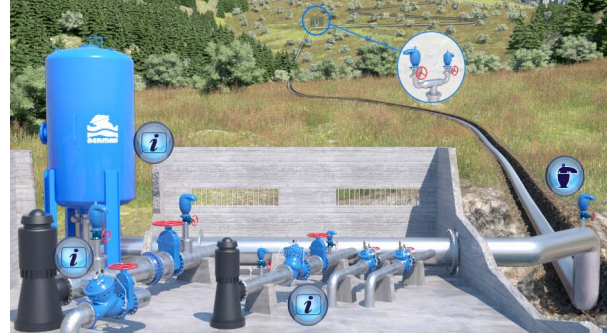

Picture 4.2 - Pumping station

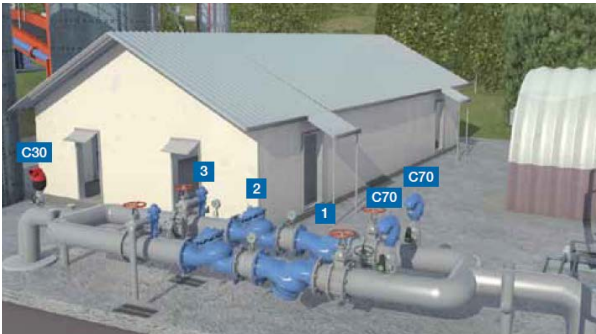

Picture 4.3 - Full redundancy Pressure Reducing system



Picture 4.4 - Main reservoir



Picture 4.5 - Elevated reservoir

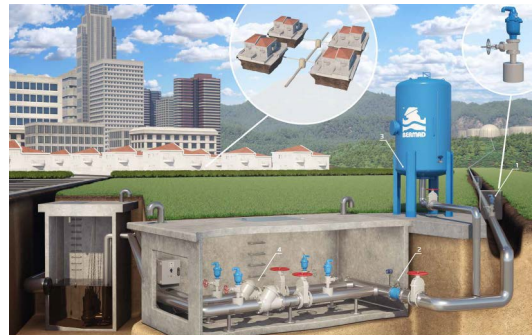

Picture 4.6 - Municipal sewage system

See additional videos and information for Air Valve's applications in Bermad City at <https://go.bermad.com/citycenter-0>

Buildings & Constructions



Picture 4.7 - On floor pressure reducing system



Picture 4.8 – On Floor pressure reducing station

See additional videos and information for Air Valve's applications in Bermad City Center at <https://go.bermad.com/citycenter>

Chapter 5 - Air Valves locations

Proper air control is a vital factor in water systems design. Appropriate location and sizing of Air Valves are critical to avoid water hammer and head loss, while achieving optimal efficiency and extending the system lifespan.

The following are guidelines for the location of Air Valves.

Along the pipeline

1. High points → Combination Air Valve

At high points, a Combination Air Valve is required for:

- Air relief during pipeline filling
- Air intake to prevent vacuum conditions in case of the pipeline being drained
- Air release of entrapped air pockets during pressurized operation.

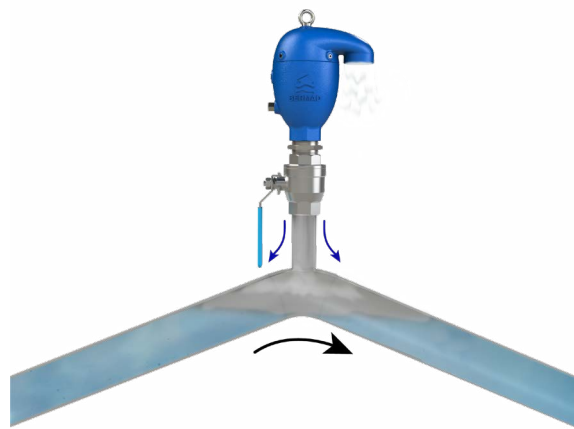

Picture 5.1 – High point

2. High points where pressure is low → Combination Air Valves + Surge Protection Feature

Same consideration like with any other high point, but with the addition of a Surge Protection (SP) feature to prevent air valve slamming during pipeline filling or any other transient scenario that might lead to water column separation.

3. Pipeline downslope increasing or upslope decreasing → Combination Air Valve

When the pipeline downslope is increasing or the upslope is decreasing, a Combination Air Valve is required to:

- Release entrapped air pockets during pressurized operation (air bubbles will be created due to pressure loss).
- Allow air into the pipeline to prevent water column separation during any transient scenario.



Picture 5.2 - Increasing downslope



Picture 5.3 - Decreasing upslope

4. Along the pipeline → Combination or Automatic Air Valve

Along horizontal sections or long ascents of the pipeline, Combination Air Valves will be required for air relief, air intake and release of entrapped air pockets during pressurized operation.

Along pipeline descents, Automatic Air Valves will be required for release of entrapped air pockets during steady state conditions.

The maximum distance between Air Valves should be 400 - 800 meters; 0.25 – 0.5 miles.

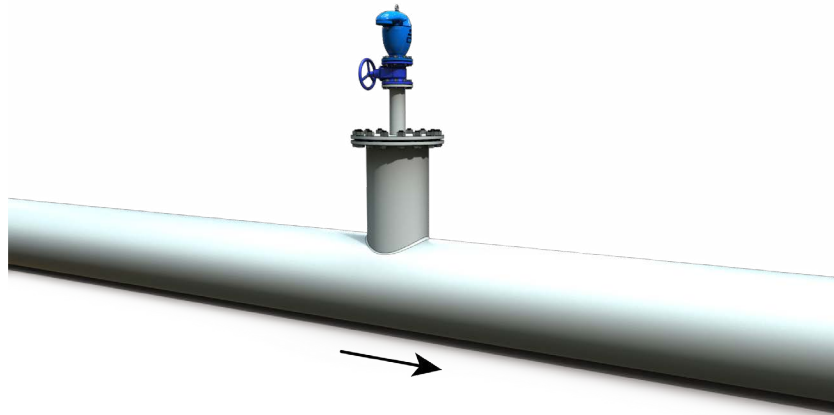

Picture 5.4 - Along horizontal pipelines

In the system

5. Pumping stations → Combination Air Valve + Surge Protection Feature

At the pump discharge pipe, downstream from the check valve, a Combination Air Valve with the addition of a Surge Protection (SP) feature will be required. In order to protect against water column separation and vacuum conditions, by ensuring controlled & safe air relief during pump start-up, shut-off or power failure.

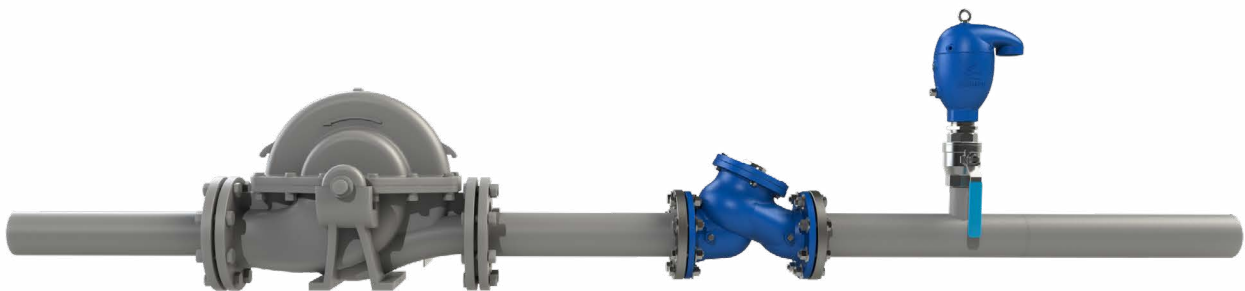

Picture 5.5 – Pumping stations, downstream the check valve

6. Deep well pumps → Combination Air Valve + Surge Protection Feature

At the pump suction pipe, between the pump and the check valve, a Combination Air Valve with the addition of a Surge Protection (SP) feature will be required to prevent vacuum conditions during pump shut-off and ensure a safe and controlled venting of the suction pipe at pump start-up.

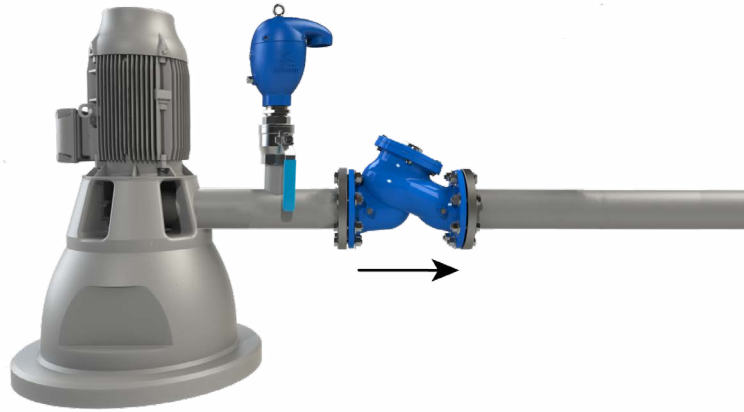

Picture 5.6 – Deep Well Pump, between the pump and the check valve

7. Crossing a road, river or canal → Automatic Air Valve

Crossing a road, river or canal is carried out through changes in the slopes. Automatic Air Valves will be required to release air bubbles, thus preventing the accumulation of air pockets at these points.

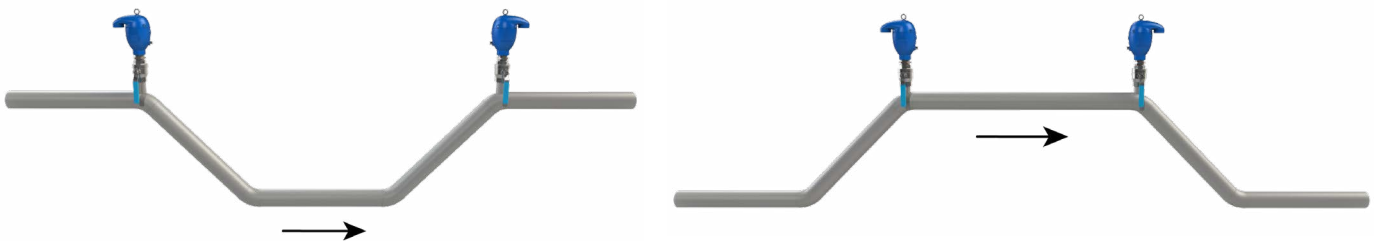

Picture 5.7 - Crossing a road, river or canal

8. Water meters → Automatic Air Valve

Upstream of water meters an Automatic Air Valve will be required to release air bubbles, which might bias the flow measurements.

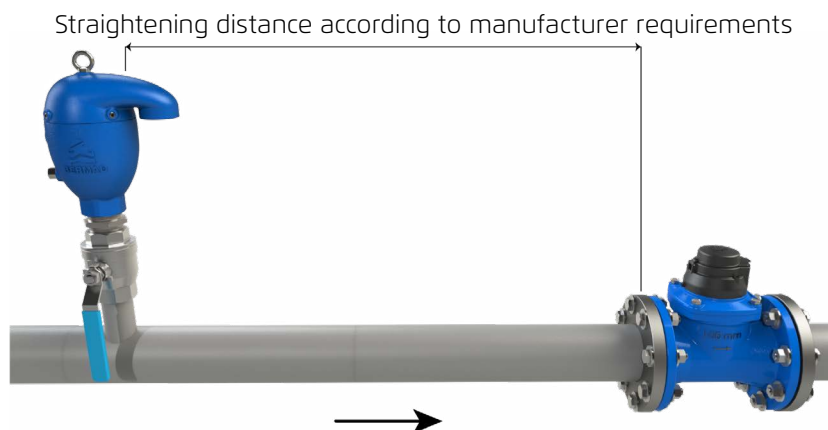

Picture 5.8 – Upstream of water meters

9. Pressure/Flow regulating valve → Automatic Air valves

Pressure reducing creates additional air bubbles downstream of regulating devices such as hydraulic control valves, etc. Automatic Air Valves will be required to release air bubbles.

In addition, the arrival of additional air bubbles might interfere with the operation of regulating devices, so installing Automatic Air Valves also at the upstream should be considered.

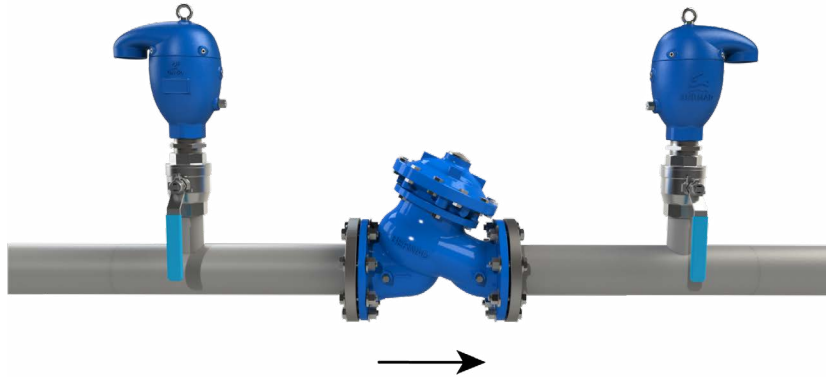

Picture 5.9 – Upstream and Downstream of regulating valves

10. Isolation valve → Combination or Kinetic Air Valve

Combination or Kinetic Air Valves will be required to prevent vacuum conditions and pipeline failure while isolation valves installed upslope, downslope or above ground are closing.

On downslope, the Air Valve will be installed downstream of the isolation/control valve.

On upslope, the air valve will be installed upstream of the isolation/control valve.

On above ground installations, Air Valves will be required both upstream and downstream.



Picture 5.10 – Isolation valve in up / down slope lines

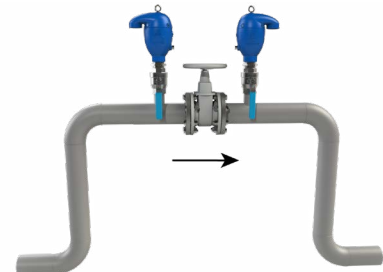

Picture 5.11 – Isolation valve above ground

11. Orifice or Restriction points → Combination or Automatic Air Valve

Combination or Automatic Air Valves will be required downstream of an orifice/restriction to reduce cavitation, noise and vibration.



Picture 5.12 - Orifice or restriction

Summary

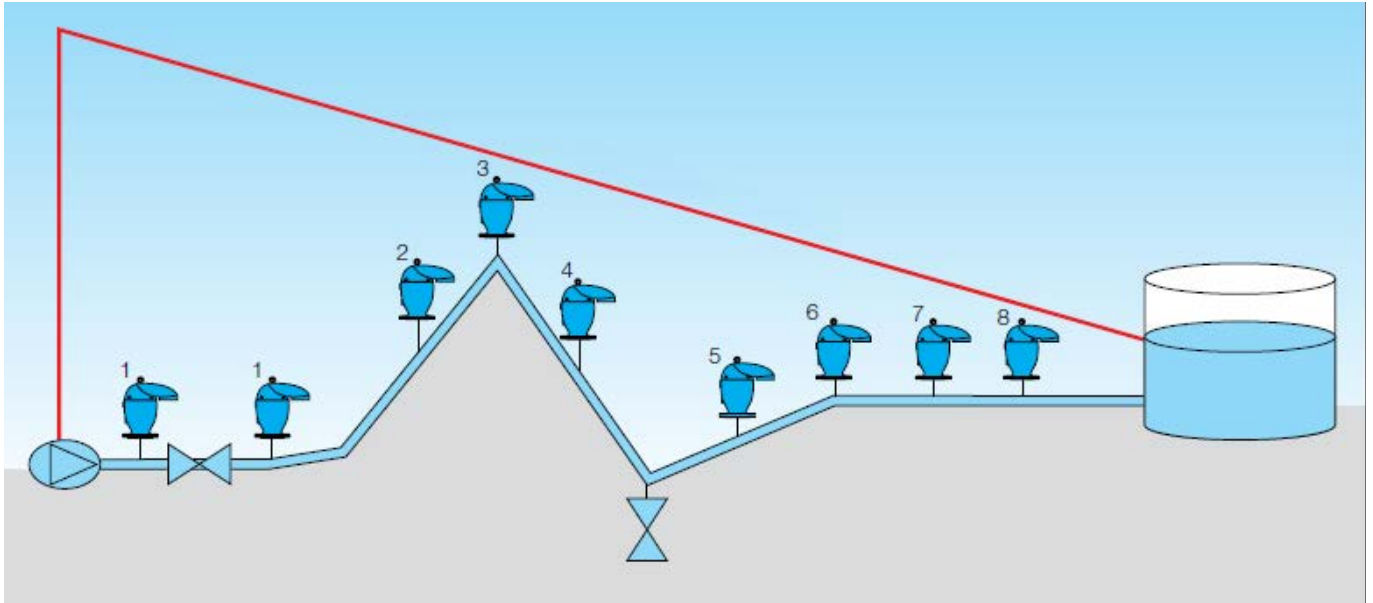

Picture 5.13 - Locations along the pipeline

Legend

- Pumping station - points 1: Combination with SP
- High point where pressure is low - Point 3: Combination with SP
- Decrease upslope - Point 6: Combination
- Long sections - Points 2, 4, 5, 7, 8: Combination or Automatic

Chapter 6 - Air Valve sizing principles

In order to optimize air control, it is important to select the proper size of the Kinetic Orifice and the Automatic Orifice for each and every Air Valve, in each specific location along the pipeline and in the system.

1) Sizing the Kinetic Orifice for Pipeline Filling (Air Relief)

The first goal is to allow an efficient pipeline filling by ensuring sufficient air relief from the pipeline. The air flow that all kinetic orifices along the pipeline have to relieve will be calculated according to the following formula:

$$Q_{air} = A \times V_{filling}$$

- Q_{air} - Required air flow (m³/hr)
- A - Pipeline cross section flow area (m²)
- V – Filling velocity (m/s)

The selected Air Valve should discharge the required air capacity at inline pressure of 3 psi; 0.2 bar.

To ensure safe & controlled pipeline filling, it is recommended not to exceed a filling velocity of 1 feet/sec; 0.3 meter/sec.

For a higher or unknown filling rate, an Air Valve with the addition of a Surge Protection device is highly recommended.

2) Sizing the Kinetic Orifice for Burst or Draining (Air Intake)

The next essential goal is to prevent vacuum conditions along the pipeline, when the system is being drained, whether due to burst or for maintenance purposes.

2.1) Rupture and Burst

The following methods are used to define the rate of air flow which required, in order to protect from vacuum conditions in case of pipe failure.

The required air intake will be calculated according to one of the following formulas:

a. Rupture

$$Q_{air} = 0.6A\sqrt{2g\Delta h}$$

- Q_{air} - Required air flow (m³/hr)
- A – Pipeline cross section flow area (m²)
- Δh - Elevation difference between pipeline failure point to the position of the air valve (m)

b. Burst (Hazen Williams equation SI units)

$$Q_{air} = 1.292 \times 10^{-5} \times C \times D^{2.63} \times \frac{\Delta h^{0.54}}{L}$$

- Q_{air} - required air flow (m³/hr)
- C – H.W coefficient
- D – Pipeline diameter (mm)
- S - Pipeline slope (m)

2.2) Drainage

This calculation refers to the required air intake through the Kinetic Orifice, while the pipeline is being drained in a controlled manner, taking into account drainage valves sizes and positions along the pipeline.

The required air flow will be calculated according to the following formula:

$$Q_{air} = 0.6A\sqrt{2g\Delta h}$$

- Q_{air} - Required air flow (m³/hr)
- A – Drainage valve cross section area (m²)
- Δh - Elevation difference between drainage valve and air valve (m)

Size Selection (based on the calculated required flow capacity)

The selected Air Valve will be the one ensuring the required air intake flow, based on the above calculations, at a negative in-line pressure not lower than the pipeline collapse pressure.

Every pipe material and class has a collapse pressure, which is the negative pressure that will cause the pipe to fail. This value is defined by the pipe manufacturer. For example, rigid pipes such as Ductile Iron/Steel pipes can handle higher negative pressures than PVC/PE/GRP pipes, which are more sensitive.

For example – if the requirement for air intake is -1,000 CFM; -1,750 m³/hr at -3 psi; -0.2 bar, then an Air Valve with an inlet of 4"; DN100 is the right selection. An Air Valve with an Inlet of 3"; DN80 does not have the required capacity.

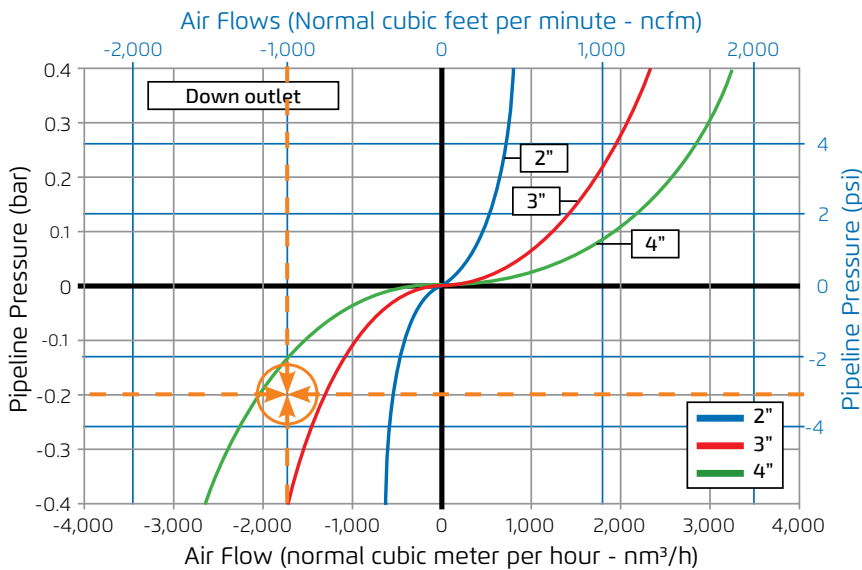

Graph 6.1 – Selecting the size of the Kinetic Orifice for pipeline draining

Actual air flow capacity of an air valve, when it is being tested in specialized air flow test bench, might be 50% lower in comparison to calculated air flow capacity based on theoretical formula.

It is important to consider only air valves, which were tested in specialized air flow test bench according to the requirements of EN-1074/4 or AS4956 standards.

3) Sizing the Automatic Orifice (Air Release)

In steady state, under pressure of 14.5 psi; 1 bar (at 77°F; 25°C) water contains about 2% solubility of air.

According to Henry's Law, the amount of dissolved air is in direct proportion to the pressure. At higher pressure, water contains higher amounts of air and vice versa. Therefore, at those points where pressure may drop (high points and others as detailed in chapter #5), air bubbles will be formed.

A conservative method is to allow each of the automatic air valves along the pipeline to release this 2% of airflow rate. However, this method will require surplus units of air valves, especially in large diameter pipelines.

As long as the automatic orifice diameter is larger than; 1 millimeter, the air valve will efficiently release entrapped volumes of air along the pipeline, whether is very large pipe to a small pipe. Thereby, sizing an automatic orifice for every given location is inessential. Yet, the designer must verify the existence of an automatic air valve for a given location, according to the guidelines in chapter #3.

Chapter 7 - BERMAD AIR - Sizing & positioning software

Introduction

Proper air control is a vital factor in water systems design. Appropriate sizing and positioning of air valves are critical to avoid water hammer and head loss, while achieving optimal efficiency and increasing the system's life time.

Selecting the right valves is a complex and time-consuming task that requires the designer to take a great number of factors into account, in addition to adjusting the system costs to the budget framework.

Informed selection of air valves

BERMAD AIR software is a state of the art, water system design tool meant to help the designer in selecting the best valves for optimized air control in water pipelines and networks while reducing the costs of the project.

The software is an engineering tool, including algorithms based on common sizing methods such as AWWA-M51. It enables every designer to reach an educated decision regarding the selection of air valves, while examining various "what if" scenarios.

BERMAD AIR modeling is especially useful for designing long water transmission lines, utilizing either pump-reservoir systems or gravity systems. Using Bermad-Air will achieve the following goals:

- Protection against vacuum conditions and pipeline collapse due to drainage or burst.
- Safe and controlled pipeline filling within a reasonable time.
- Enhanced system efficiency during pressurized operation.
- Improved Surge Protection solutions.
- Reduced air valve procurement costs.

Registration

BERMAD AIR is available free of charge to any water system designer. It is a standalone software that can be downloaded onto any personal computer. [Click here](#) to register and download Bermad Air.

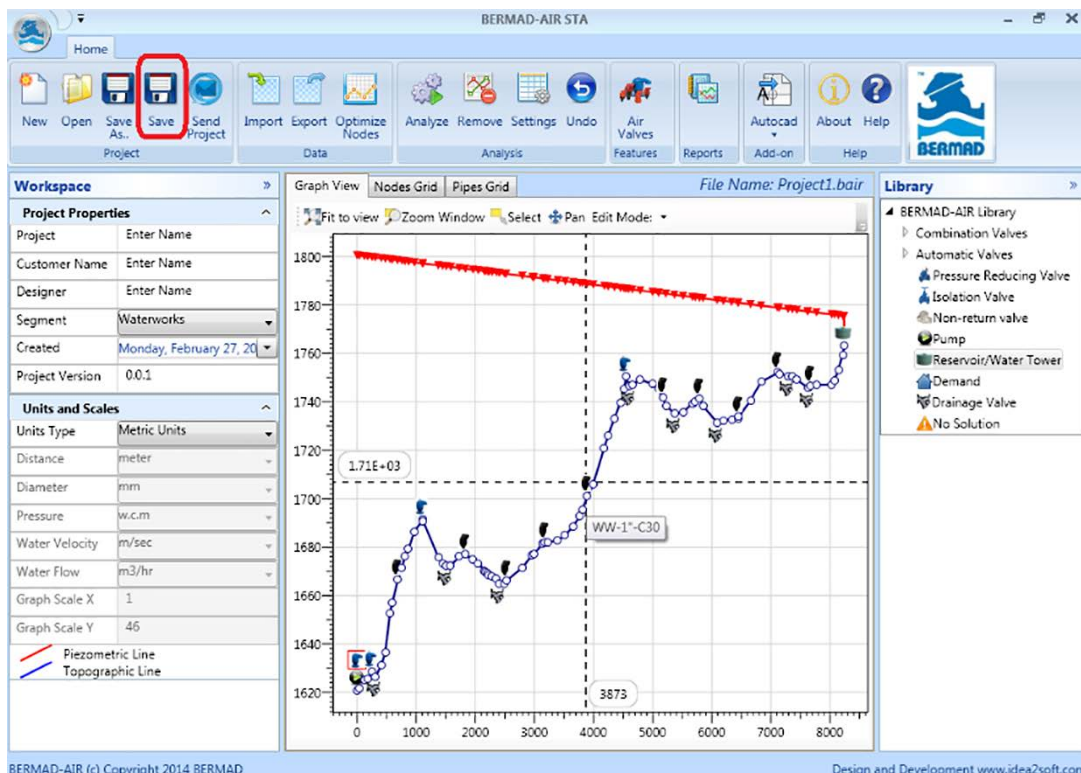

Picture 7.1 – BERMAD AIR's user interface

Scenarios for Analysis

Based on the project data, BERMAD AIR analyzes the required airflow rate at various scenarios including:

- Pipeline filling
- Burst or Rupture
- Drainage
- Maximum distance between nodes
- Column separation
- Critical velocity

According to the analysis results and the designer's specifications, the software automatically selects Air Valves' features (including quantity, material, diameter, connection type, coating, outlet, and others) for the recommended solution, along with catalog numbers for each and every model.

BERMAD AIR main features

- **Real air relief and air intake data**

Air valve selection is based on actual airflow measurements for each model and size, to ensure optimal design. The valves' data used in BERMAD AIR is a result of testing Bermad air valves in an Air Flow Test Bench, according to standards EN-1074/4 and AS4956 and represents the real and actual, not theoretical, performance. This contributes to lowering procurement costs, by avoiding oversized and/or unnecessary valves.

- **Easy data upload** – Users can upload data manually or directly from AutoCad or MS Excel.

- **Eliminate errors due to inaccurate topographical calculation**

High points along the pipeline are critical locations in the analysis. About 80% of the air valves are located at high points. Therefore, determining the high points properly to prevent inefficiency is essential.

- **Comprehensive applications**

BERMAD AIR offers integration of pressure reducing valves, drainage valves and consideration of demand nodes.

- **Integrated graphic display and reports interface** – BERMAD AIR's drag-and-drop interface is one of the most user-friendly in the industry. Once generated, the report includes:

- System data
- Parameters taken into consideration
- List of selected air valve models and their features
- Chart with location of the Air Valves at each node

- Reports includes complete BOQ can be downloaded into PDF or Excel files

- **Full technical support** – If required, the project can be e-mailed to BERMAD's Application Engineers for further technical support.

NOTE

BERMAD-AIR is designed based on real flow rates measurements of BERMAD air valves. Hence result are valid for BERMAD products only. It's incorrect and risky to consider BERMAD-AIR results for another air valve manufacturer, especially with regards to the difference in performance for both inflow and outflow.

Chapter 8 – Preliminary sizing graphs

Bermad Application Engineering approach is always to use Bermad Air software for professional and accurate sizing & positioning of Air Valves. However, for a purpose of preliminary selection or a rough order of magnitude, the following graphs can be used.

The following graphs for sizing are based on solely 2 parameters: pipe diameter and pipe gradient (slope).

For example: for a 12"; DN300 pipe with 7m/100m slope, the required air flow rate is 350 m³/hr and therefore 1 unit of C10/C30 with an inlet of 2"; DN50 is sufficient.

Combination Air Valves

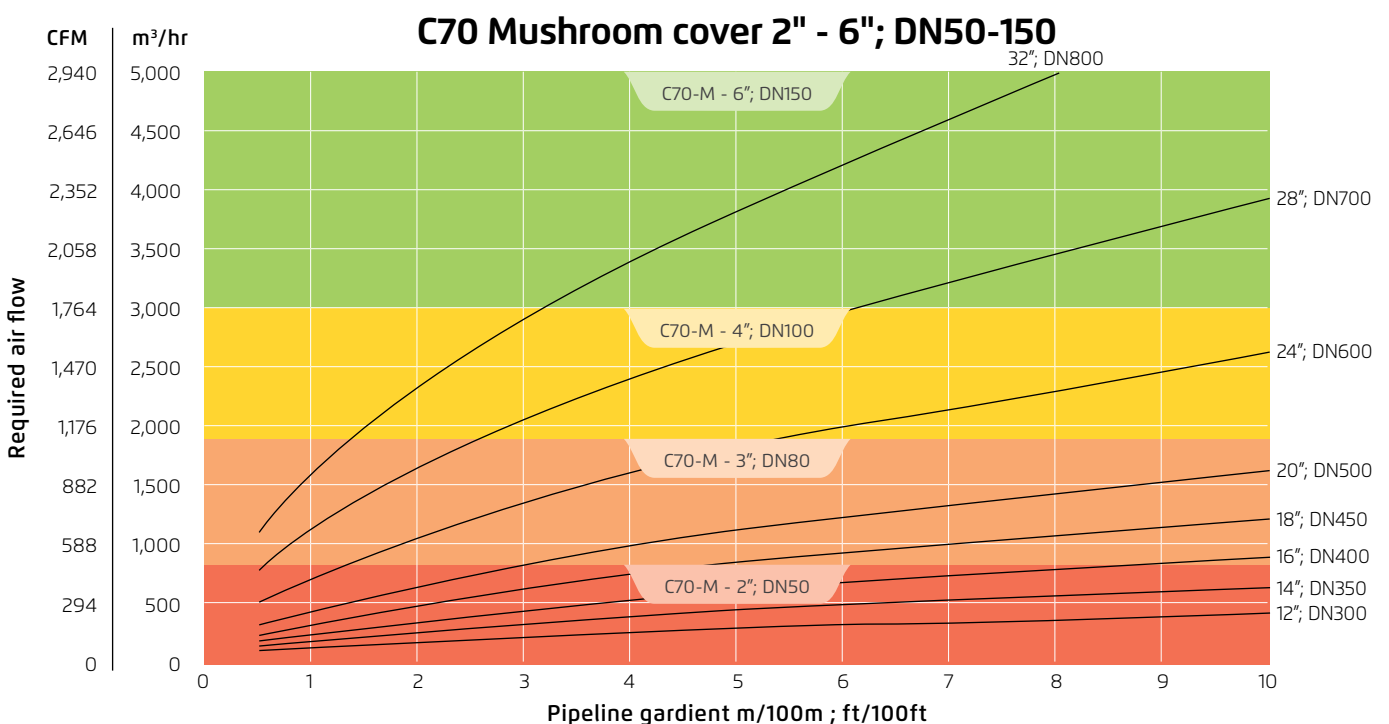
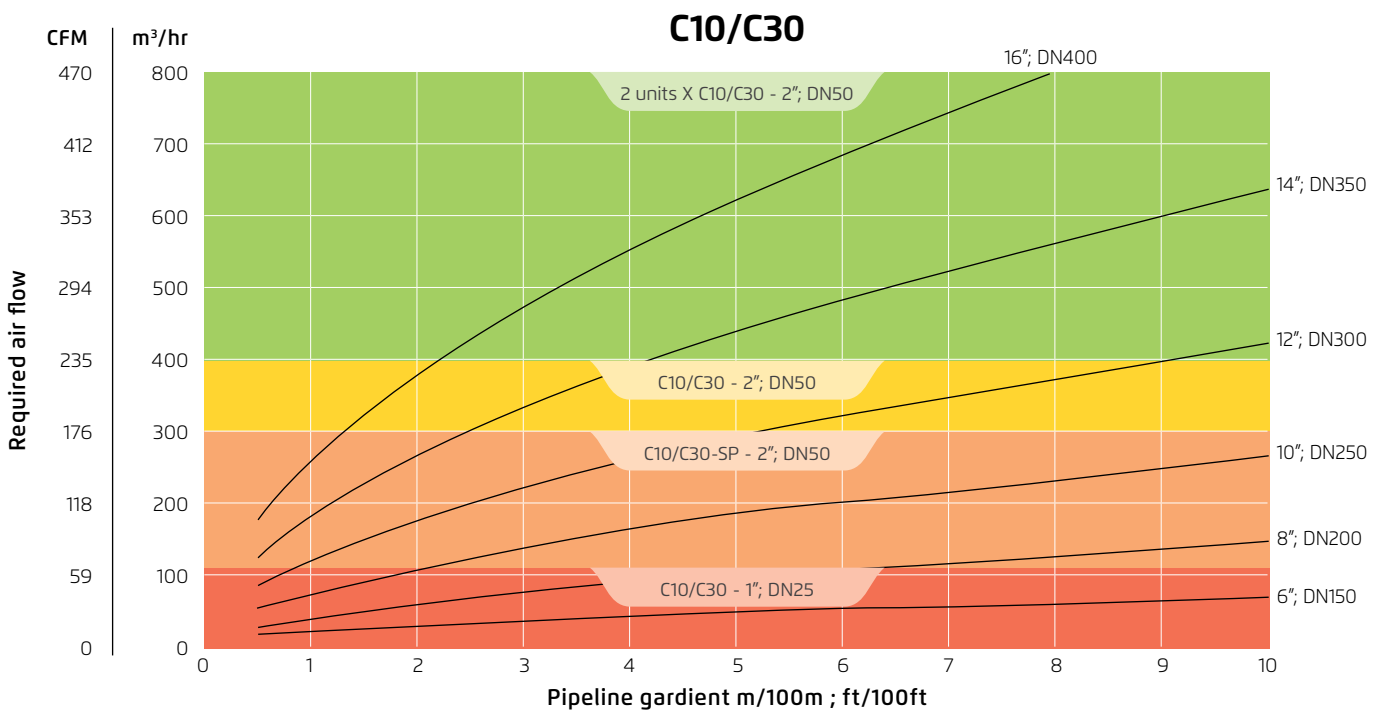

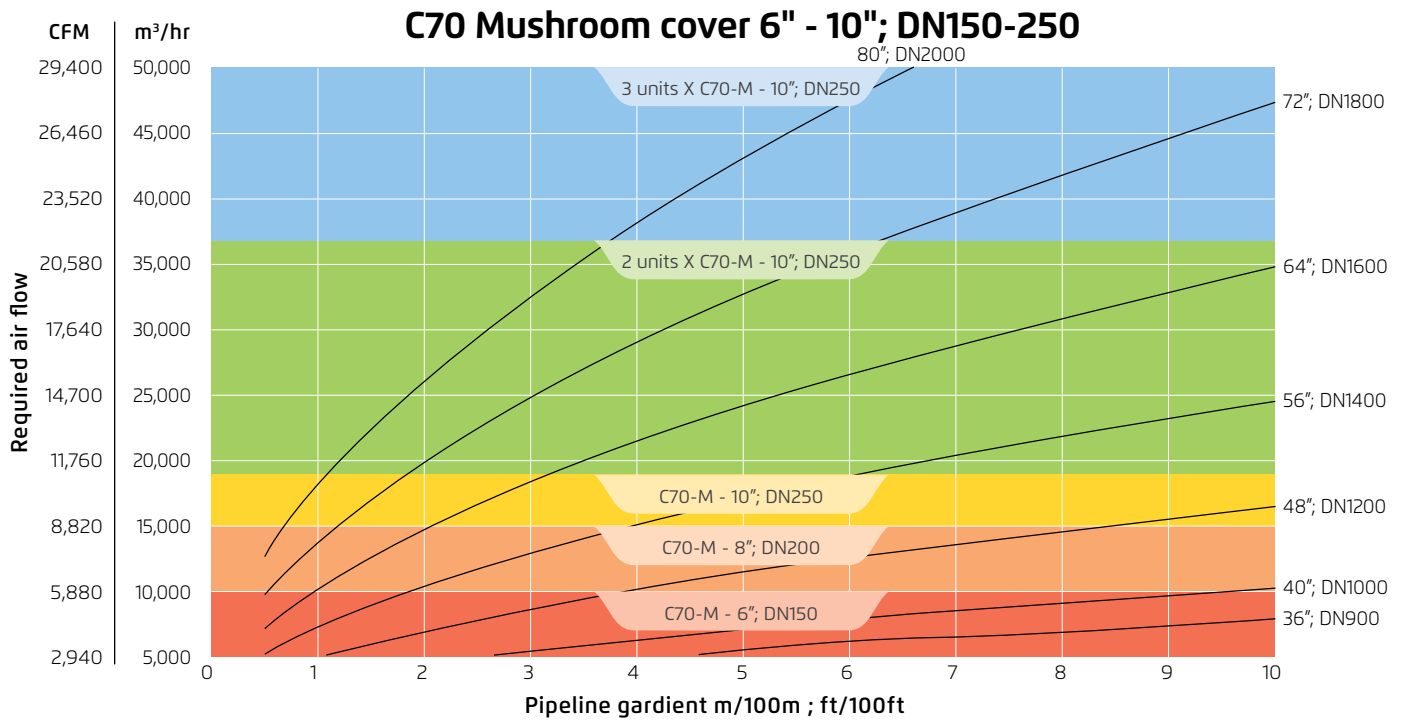

Sewage & Wastewater Combination Air Valves

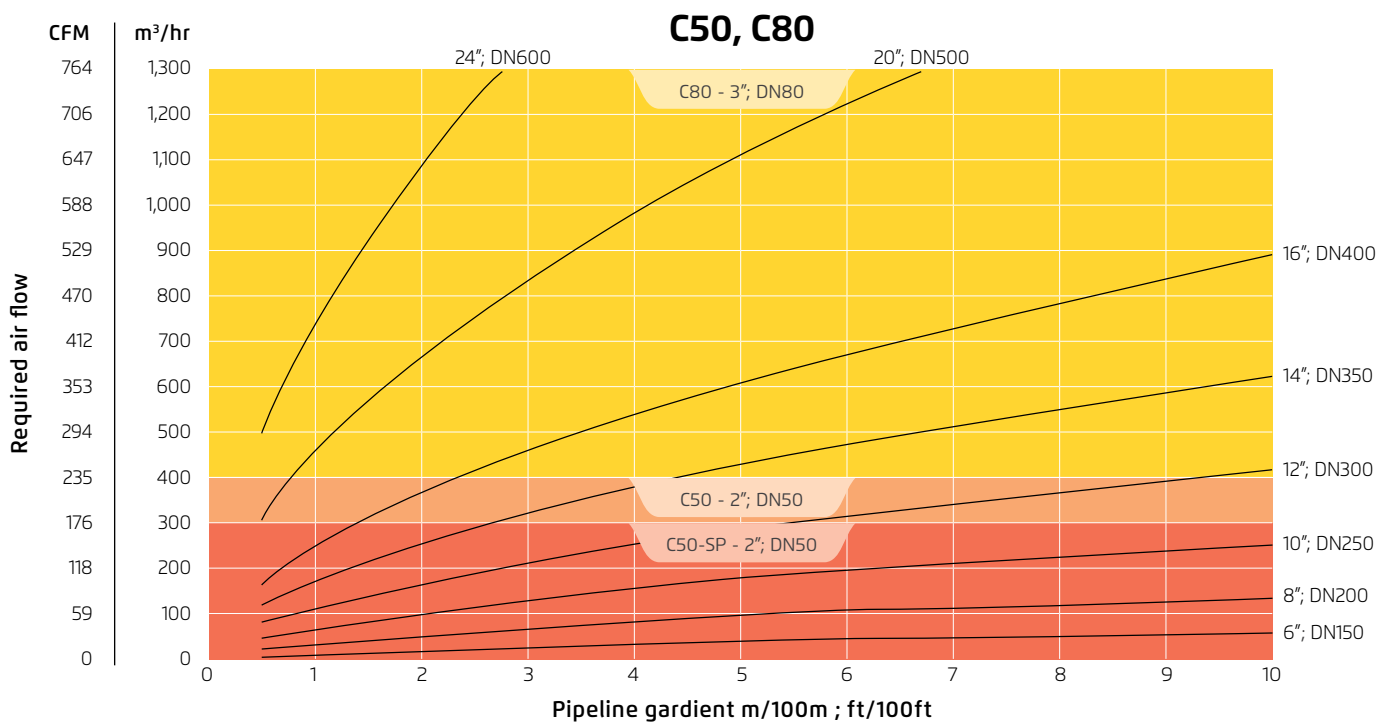

Disclaimer - These graphs are provided "as is" and BERMAD (i) accepts no liabilities whatsoever for any loss or damage arising from any use of these graphs (ii) shall not be held liable for any damage or loss, caused to any party arising from any use of or reliance on these graphs and (iii) explicitly excludes any liability for any claim and liability, regardless of the form of action, whether under contract, tort, negligence or otherwise at law.

© Copyright Bermad CS Ltd. 2021. All rights reserved.

Chapter 9 - Surge analysis

Introduction

Water hammer or pressure surge is a phenomenon that occurs in water systems with sudden changes in flow velocity. The consequences can be devastating, both to the system and the environment. Air valves have a fundamental role in scenarios of transient flow, such as water hammer. The most significant is their air intake capability, in order to alleviate or eliminate down surge. In addition, air valves are required to prevent water column separation that can easily enhance surge. On the other hand, uncontrolled air relief during pipeline filling, due to incorrect or over sizing, is also risky and may lead to secondary surge.

BERMAD's surge analysis service

Bermad offers a free of charge surge analysis service, as support to system's designers.

Designers are required to submit an Excel form with all relevant data about the system: pumps, pumping station layout, reservoirs, pipeline properties & profile and more.

Surge analysis enables the designer to predict the maximum & minimum pressures along the system under different scenarios, potentially leading to pressure surge, such as: pumps trip, valve closing, rapid change in demand, etc.

Pumping stations, high peaks and points with low steady state pressure are usually at high risk for down surge (vacuum conditions).

Performing surge analysis

The software analyzes the air valves performance in various scenarios, allowing the adjustment of the air valves characteristics for optimal surge elimination. The software addresses the following parameters: air relief, air intake, surge protection (SP) disc size and switching pressure and more.

Main stages:

- A. Importing system data to the surge software while ensuring that the hydraulic conditions in the model are similar to the data received from the client (Steady State condition).
- B. Defining the worst case scenario and running transient (surge) analysis without any protection to estimate the magnitude of up surge & down surge throughout the entire system.
- C. Running several iterations with surge protection solutions, seeking optimal product selection to provide the most cost-effective solution.
- D. Summary and formulation of reports.

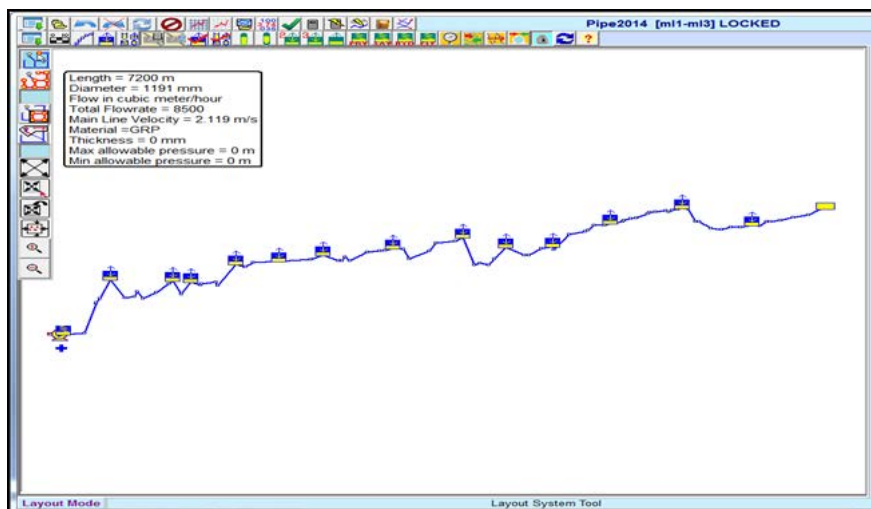

Picture 9.1 – Surge Analysis software user interface

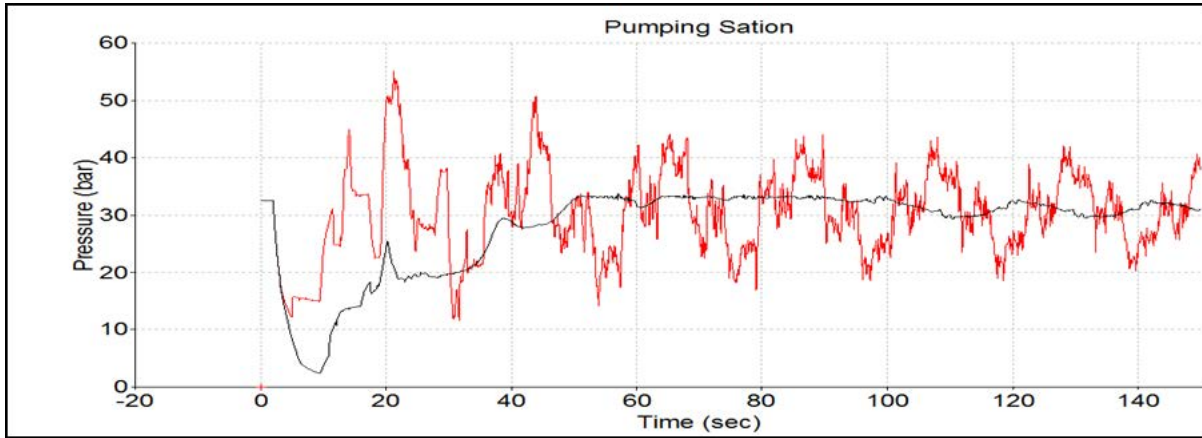

Picture 9.2 - Pressure at the pumping station with and without protection

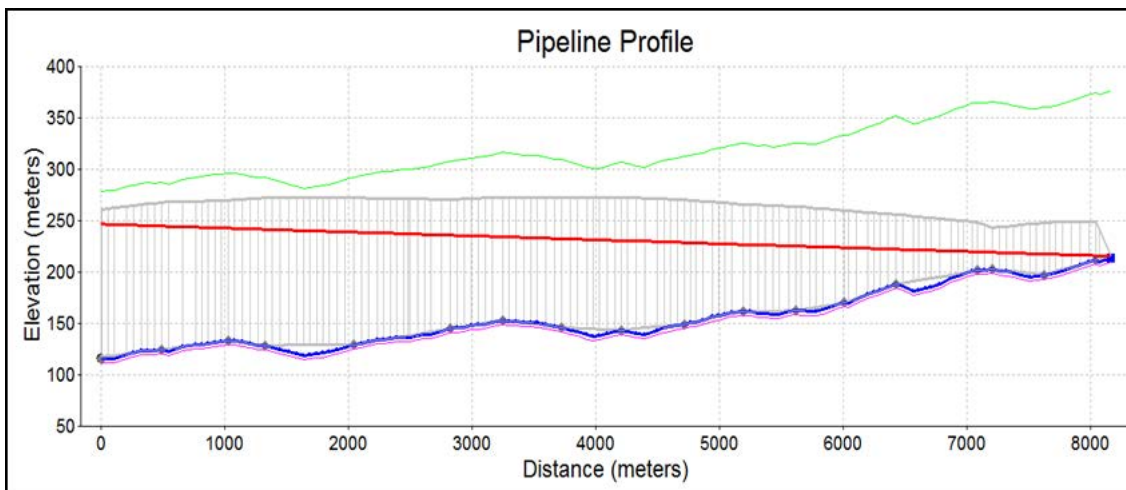

Picture 10.3 - Maximum & minimum pressure/head along the pipeline

Chapter 10 - Air Valves specifications

Once the designer has decided on the selected air valves, it is important to specify all their requirements in the project engineering & procurement data. Accurate specifications will ensure compliance with all requirements.

The table below indicates important points for proper air valve specifications.

[Click here](#) to download the full Bermad Air Valves specifications document.

Specifications	Content
Air valves type	Clean or Non Clean water Combination, Automatic or Kinetic
Construction materials & coatings	Body and Cover construction materials Type of coating for metal air valves Internal parts materials
Operational data	Maximum operating pressure Minimum operating pressure (low pressure sealing) Water temperature
Air valve inlet size and connection	Inlet connection size Threaded - BSP or NPT Flange - type of standard
Air flow capacity of the kinetic orifice (air relief/intake)	Size of the Kinetic orifice Nominal / Full Bore - equal to the inlet connection size Reduced - smaller than the inlet connection size Define the required airflow at selected points - both during negative pressure (draining or burst) and positive pressure (pipeline filling).
Air valves additional features	Surge Protection (SP) Inflow Prevention (IP) Assisted Closing (AC)
Accessories	Type of cover - down, side, mushroom Service port Insect screen Drainage valve
Testing Capabilities	Published airflow curves and data have to be based on actual measurements in a specialized airflow test bench (as specified in EN-1074/4, AS4956) including negative pressure conditions.

Chapter 11 - Installation considerations

This section provides important considerations about how to design air valves installation for optimal operation.

Riser

Air Valves have to be installed on vertical risers, at a 90° angle to the horizon. Non-vertical installation may disturb the air valves proper performance. The risers diameter has to be equal to the air valve inlet diameter or larger.

The riser should ideally be within 5 degrees of vertical for optimum operation.

Isolation valve

To allow maintenance, isolation valve must be installed between the pipeline and the air valve. During operational mode, the isolation valve has to be fully opened (not partially).

Ideally the isolation valve should be full port such as a Gate, Ball or Knife valve not to impede the air valve performance. Butterfly valves can be used to isolate on flanged valves, but could have an effect on operation and air capacity.

They are typically suggested when height is an issue. Ensure butterfly valve model is designed for end of line service to enable air valve removal under pressure.

Drainage pipe

When required, a drainage pipe should be fitted to the valve's outlet. The pipe's diameter should be at least equal to the inlet size of the air valve. A smaller diameter may reduce the air valve flow capacity.



Picture 10.1 - Air Valve installation

Air collection chamber

It is highly recommended to design a collection chamber (air trap) underneath the air valve. During pressurized operation, air pockets will be captured temporarily in the chamber, to be released through the automatic orifice of the air valve.

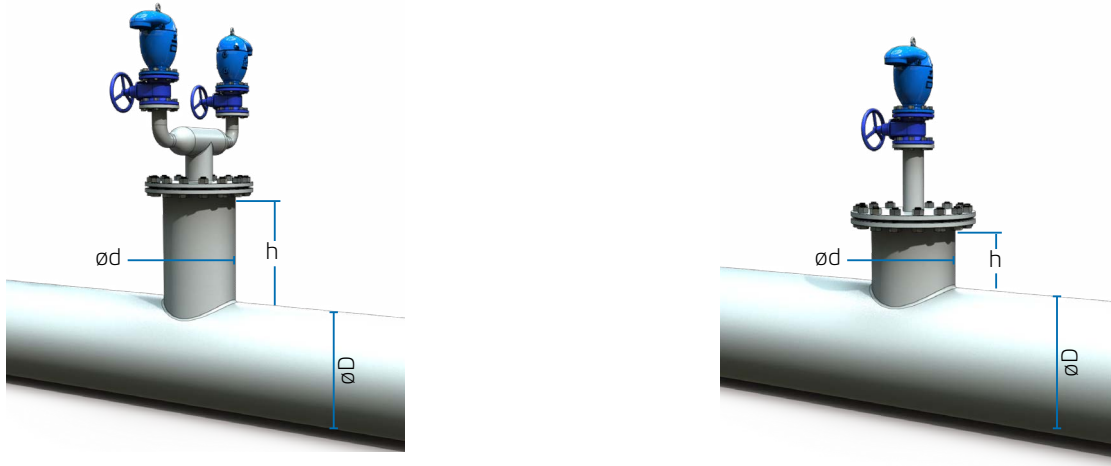

Picture 10.2 – Air collection chamber

	$D \leq 12''; 300 \text{ mm}$	$12''; 300 \text{ mm} < D \leq 60''; 1,500 \text{ mm}$	$D > 60''; 1,500 \text{ mm}$
ϕd Diameter	$\phi d = D$	$\phi d = 0.6D$	$\phi d \geq 0.35D$
h Height	$h \geq D \ \& \ h \geq 6''; 150 \text{ mm}$		

- * Please note – the table above refers to Combination or Automatic air valves only.
- ** For Kinetic / Air Vacuum valves, air collection chambers are not needed, consider only the height.
- *** In raw sewage systems air collection chambers are not recommended. Since they become trap for wipes, diapers and other large suspended particles.

Underground / Pit installation

The vent pipes should have an open area of 1.5 times (or greater) of the kinetic orifice of the air valve to ensure correct performance of the air valve. If the pit has the opportunity to submerge the air valve, then install a threaded outlet air valve and hard plumb above ground to avoid contaminated water entering the pipeline under vacuum.

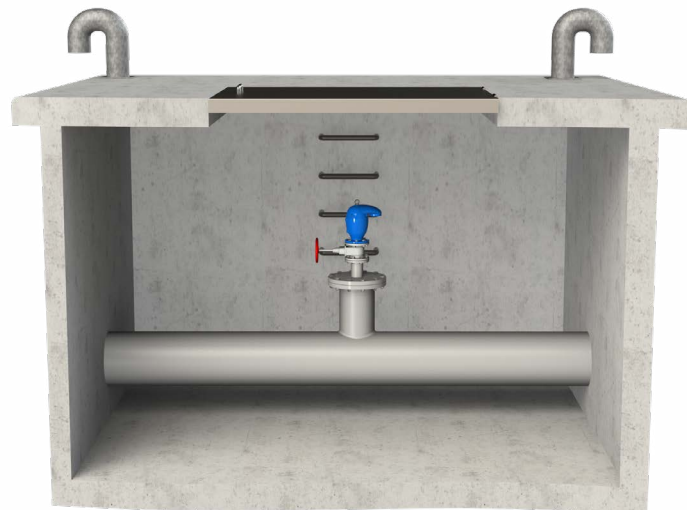

Picture 10.3 - Underground Installation

Chapter 12 - BERMAD air flow test bench for air valves

Air valves are simple components, but essential for the efficient operation of water networks and protection from vacuum conditions. Air in the system has to be controlled by correctly sizing and positioning air valves. Their sizing should be based on their air flow performance in the real world. Due to the complexity in replicating real operation conditions with enough air flow capacity, only few manufacturers use air flow test equipment. As part of the development of its line of air valves, BERMAD has built an advanced and innovative air flow test bench.



Features of a unique test bench

Built in Kibbutz Evron (Northern Israel), this installation has been designed to develop and test air valves up to 8"; DN200 in real conditions of air intake and relief. Its heart is a 350 kW blower, able to generate high flow rates up to 8,500 cfm; 15,000 m³/h and +7.5psi; 0.5 bar positive pressure for air relief and - 7.5 psi; -0.5 bar negative pressure for air intake.

In addition to verifying the BERMAD air valves air flow capacity according to their technical engineering design, the test bench is a basic tool for quality control and for the development of new products. It has been designed according to the EN-1074/4 Standard, and AS 4956:2017 Australian Standard.

The air flow test bench allows on line data gathering of the pressure, flow and temperature during pipe line filling and pipeline draining (vacuum condition). This data is presented in the air flow curves in the product pages and also being used in BERMAD Air data base. The measurements' results were found to be consistent and repeatable by experts from the water industry.

Why the test bench is important

On the basis of innumerable tests performed in the BERMAD test bench on different manufacturers' air valves, we issue the following recommendations:

- Test results reveal the necessity to choose the air valve according to its air flow capacity and not according to its inlet connection diameter. This becomes evident looking at the wide gap in the results obtained by valves having the same inlet diameter but different internal aerodynamic design.
- Having actual air flow measurements, able to replicate real operation conditions, is extremely important. Air Flow data obtained by simpler methods and mathematical simulations may be far from reflecting reality. BERMAD-Air (www.BERMAD-air.com) software for air valve's sizing and positioning uses real data as obtained at our test bench.
- Determining the closing point of the air valve in its air releasing phase is essential to prevent problems derived from premature closing.

Chapter 13 – BERMAD Air Valves – Why they are better for your system

Control of air in water systems is as essential as control of water. That’s why BERMAD engineers have devoted years of reaserch and development to improve air control in water systems focusing on practical performance testing along with an in-depth evaluation of today’s current range of air valve technologies. This extensive research has led to the development of an innovative new line of air valves based on the most advanced flow analysis and engineering tools available. It also led to the development of a unique modern test bench that serves both as a development tool and a quality assurance tool.

The line of BERMAD Air Valves include Metal Air Valves ranging from 2” to 8” and Plastic Air Valves from ¾” to 2” for a variety of Water, Sewage and Waste water pipeline and networks offering:



- Higher flow rates - Advanced aerodynamic design with a straight-flow body allowing higher flow rates than ever before.
- Low pressure sealing - all BERMAD Air Valves’ operate with a minimal operating pressure (0.1bar/1.5psi).
- Built-in surge protection (anti-slam feature) - Responds to the approach of high velocity water column by slow air relief, preventing damage to the valve and to the entire system. Can be added to the air valve after installation.
- Robust design - including solid floats, which designed for intense working conditions and endure pressure surges.
- Certifications - BERMAD Air Valves are certified by international functional standards (EN-1074/4 ,WRAS, AS4956). The WW models also carry water service standards (NSF, WRAS, ACS, AS4020).
- Reliable air flow data - based on actual air flow measurements in specialized air flow test bench, which contributes to better system optimization.
- Application engineering support - recommendations based on sizing & positioning engineering tool (BERMAD Air) and Surge Analysis services.

BERMAD’s advanced line of air valves joins our extensive line of hydraulic control valves to create comprehensive control solutions for pressurized pipelines and networks. System engineers and end-users can now design and install far more optimized solutions for their system requirements.





Chapter 14 – Bermad Air Valves certifications

Functional Standards

	European Union	EN-1074/4	C70
	Russia	GOST	A30, C30, C50, C70
	China	CNA National Quality Supervision and Inspection Centre of Pump and Valve Products	C70
	Bulgaria	EN-1074/4	A10, A30, A31, C30, C70, K10

Drinking Water standards

	USA	NSF/ANSI/CAN 61	A30, A31, A71, C30, C35, C70, C75
	UK	WRAS	A30, C30, C70
	Australia	AS4020 & AS4956	C10, C30, C70

Chapter 15 - BERMAD Air Valves product matrix

Type	Pressure Rating	Model	Body Construction Material	Inlet Connection Sizes									
				¾" DN20	1" DN25"	2" DN50	3" DN80	4" DN100	6" DN150	8" DN200	10" DN250	12" DN300	
Automatic; Air Release	150 psi; PN10	A10	Reinforced Nylon	■	■								
Automatic; Air Release	230 psi; PN16	A30	Reinforced Nylon	■	■								
Automatic; Air Release	230-360 psi; PN16-25	A71	Stainless Steel	■	■								
Automatic; Air Release	250-900 psi; PN16-64	A72	Ductile Iron, Cast Steel		■								
Combinaton	150 psi; PN10	C10	Reinforced Nylon	■	■	■	■						
Combinaton	150 psi; PN10	C15	Reinforced Nylon			■							
Combinaton	230 psi; PN16	C30-P	Reinforced Nylon	■	■	■	■						
Combinaton	230 psi; PN16	C30-C	Ductile Iron		■	■							
Combinaton	230 psi; PN16	C35	Reinforced Nylon			■							
Combinaton	230-580 psi; PN16-40	C70-C	Ductile Iron			■	■	■	■	■	■	■	
Combinaton	230-580 psi; PN16-40	C70-S/N	Cast Steel, Stainless Steel			■	■	■	■				
Combinaton	230-580 psi; PN16-40	C75-C	Ductile Iron				■	■	■	■	■	■	■
Combinaton	230-580 psi; PN16-40	C75-S/N	Cast Steel, Stainless Steel				■	■	■	■			
Kinetic	150 psi; PN10	K10	Reinforced Nylon	■	■	■							
Combinaton*	150 psi; PN10	C50-P	Reinforced Nylon			■	■	■					
Combinaton*	230 psi; PN16	C50-C/J	Ductile Iron			■	■	■					
Combinaton*	230 psi; PN16	C50-N/G	Stainless Steel			■	■	■					
Combinaton*	230-360 psi; PN16-25	C80	Ductile Iron				■	■					

* For sewage & wastewater

AIR CONTROL IN WATER SYSTEM - A GUIDE FOR THE SYSTEM'S DESIGNER, Bermad Disclaimer

You are welcome to use this Guide for the Water System's Designer (the "Guide") for air-valves purchased from BERMAD CS LTD. or any of its affiliates ("BERMAD").

The information contained in this Guide should be used only by professional water systems engineers and designers, who can fully understand it and the risks involved therewith.

Although BERMAD has made every effort to ensure that this Guide is accurate; BERMAD disclaims liability for any inaccuracies or omissions that may have occurred.

All the procedures, drawings, pictures and any other information provided in this Guide are presented as general information only, BERMAD makes no commitment to update or keep the information in this Guide current or up-to-date, and BERMAD reserves the right to make improvements, alterations and modifications to this Guide, at any time without providing any notice thereof.

This disclaimer will not be deemed to broaden the scope or extend the validity of any warranty given by BERMAD for the relevant product whilst in no event the liability of BERMAD, whether under contract, tort, negligence or otherwise at law for loss or damage arising from or in connection with this Guide - shall exceed the purchase price actually paid by the claimant to BERMAD for the relevant product.

BERMAD explicitly excludes any liability for special, incidental, or consequential damages as well as for defects or damages resulting from accident, force majeure, inappropriate physical or operational environment, improper installation, operation or maintenance, or modification, negligence or fault by any party other than BERMAD.

© Copyright Bermad CS Ltd. 2021. All rights reserved.

About BERMAD

BERMAD is a leading, privately-owned global company that designs, develops and manufactures tailor-made water & flow management solutions that include state-of-the-art hydraulic control valves, air valves and advanced metering solutions.

Founded in 1965, we have spent over 50 years interacting with the world's major end users,

and accumulating knowledge and experience in multiple markets and industries. Today, we are recognized as a pioneer and established world-leading provider of water & flow management solutions that give our customers the unprecedented operational efficiency, and superior quality, durability and performance they need to meet the demanding challenges of the 21st century.

